

möller

deco technik

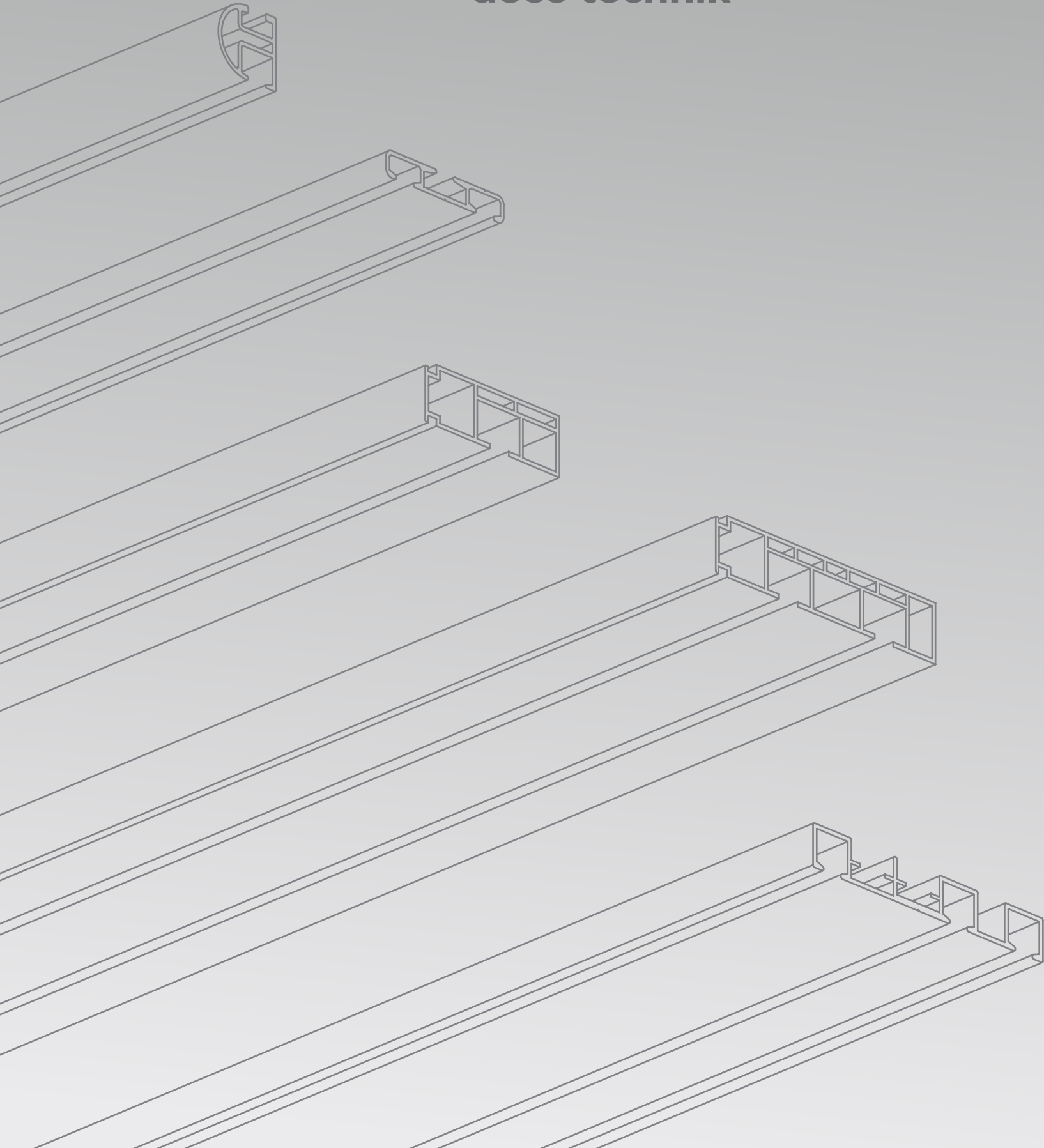

INHALT

CONTENT

KUNSTSTOFFSCHIENEN

PLASTIC RAILS

PRODUKTFINDER

PRODUCTFINDER

252

SYSTEM SM-PLUS

254

SYSTEM CM

284

SYSTEM BM

314

KUNSTSTOFFPROFILE

PLASTIC PROFILES

336

KUNSTSTOFFSCHIENEN

PLASTIC RAILS

KUNSTSTOFF- PROFILE

PLASTIC PROFILES



DOPPELFLANSCHIGE VORHANGSCHIENE 200

CURTAIN RAIL WITH
DOUBLE FLANGE



EINFLANSCHIGE VORHANGSCHIENE 201

CURTAIN RAIL WITH
SINGLE FLANGE

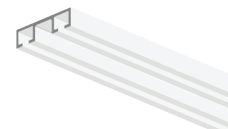

ZWEILÄUFIGE INNENLAUFSCHIENE

DOUBLE-TRACK
INNER RAIL



U-VORHANGSCHIENE FÜR GLEITER

U-CURTAIN RAIL
FOR GLIDER

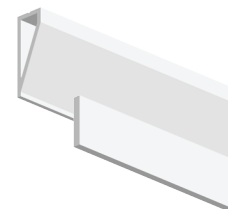

KUNSTSTOFF-PANEELWAGEN INKL. KLETTBAND UND BESCHWERUNGSPROFIL

PLASTIC PANEL TRACK WITH
VELCRO AND BOTTOM
WEIGHT PROFILE



SYSTEM SM-PLUS

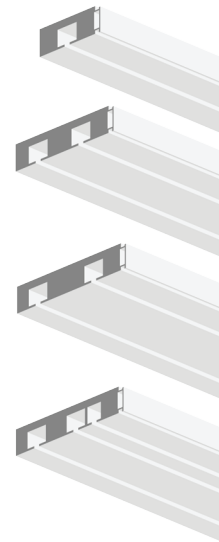

SYSTEM 1-48



SYSTEM 2-78



SYSTEM 2W-88



SYSTEM 3-88



BLENDE

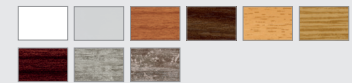

SYSTEM CM

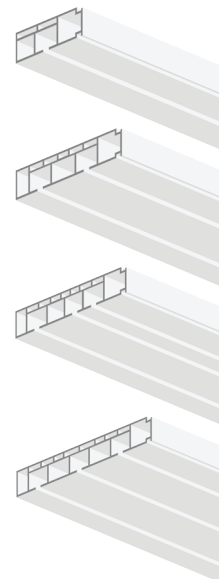

SYSTEM 1-48



SYSTEM 2-78



SYSTEM 3-88



SYSTEM 3-112



BLENDE

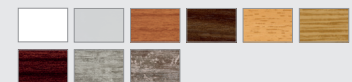

KUNSTSTOFFSCHIENEN

PLASTIC RAILS

SYSTEM BM

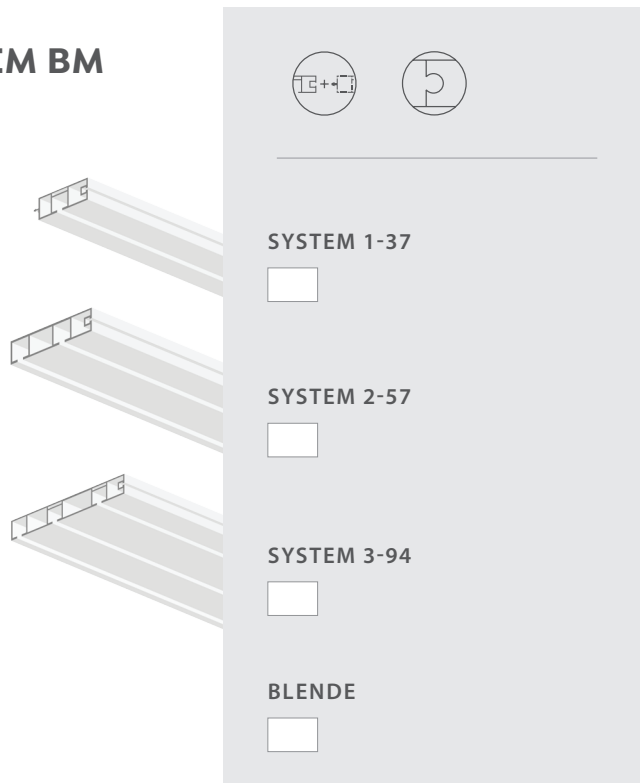

SCHIENEN-DEKORE

DECORS OF RAILS



weiß /
white

BLENDE-DEKORE

DECORS OF PELMETS



weiß /
white



silber-matt /
silver-matt

BLENDE-DEKORE (LÄNGSMASERUNG)

DECORS OF PELMETS (HORIZONTAL GRAIN)



kirschbaum /
cherry tree



nussbaum /
walnut



buche /
beech



eiche-hell /
light-oak



mahagoni /
mahogany



platin-antik /
platinum-antique



kupfer-antik /
copper-antique

LEGENDE

LEGEND



INTEGRIERTE
BLENDENAUFNAHME
INTEGRATED PELMET
RECEPTION



VIELFÄLTIGES
BOGENZUBEHÖR
A GREAT VARIETY OF BOW
ACCESSORIES



VORGEBOHRT
PRE-DRILLED



DIVERSE BLENDEDEKORE
VARIOUS PELMET
DECORATIONS



BESONDERS LEISE
EXTRA QUIET



ANZAHL DER SCHIENENLÄUFE
BELIEBIG ERWEITERBAR
NUMBER OF RAIL TRACKS
FREELY EXPANDABLE



EINFACHES
STECKSYSTEM
SIMPLE PLUG-IN SYSTEM

SYSTEM SM-PLUS

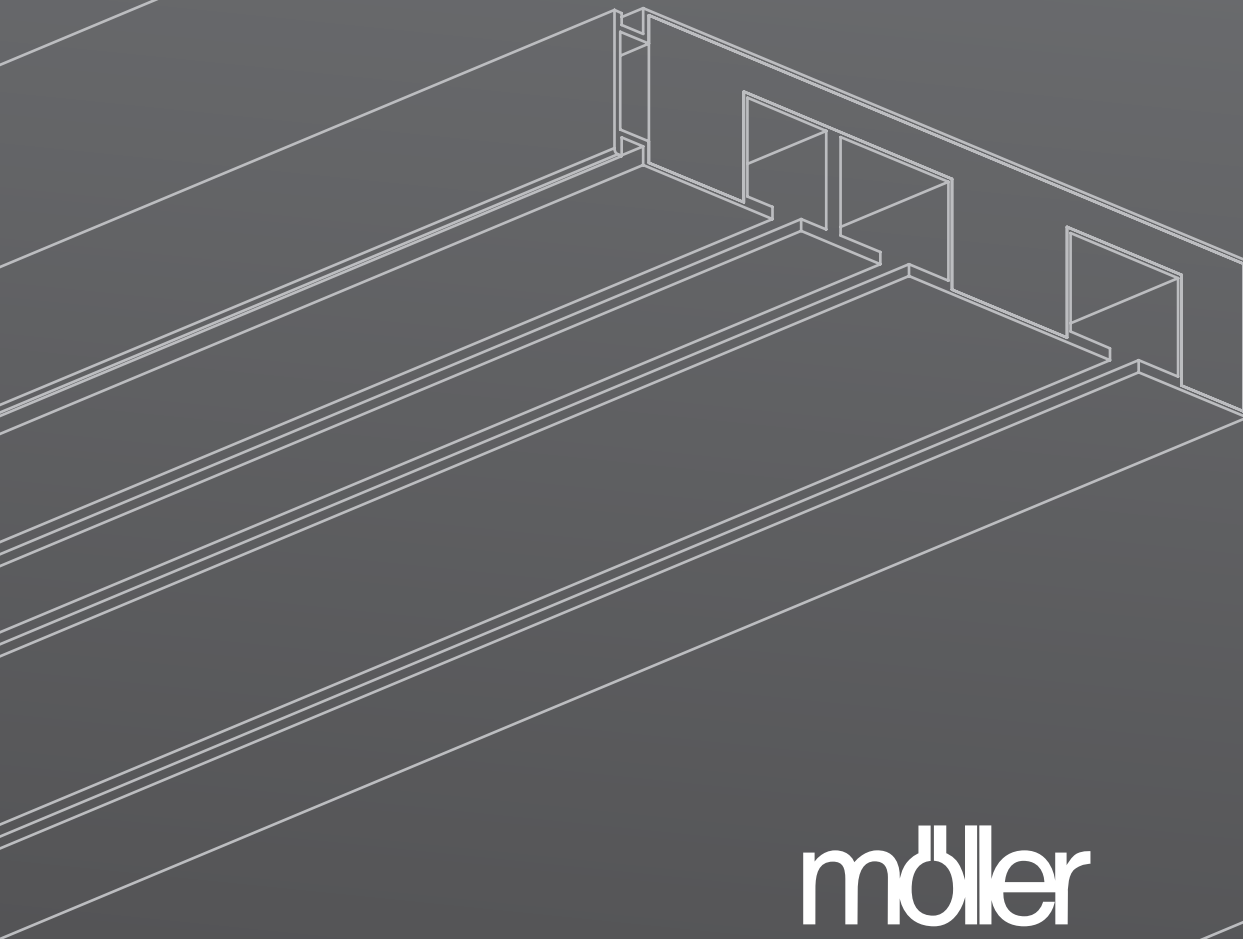
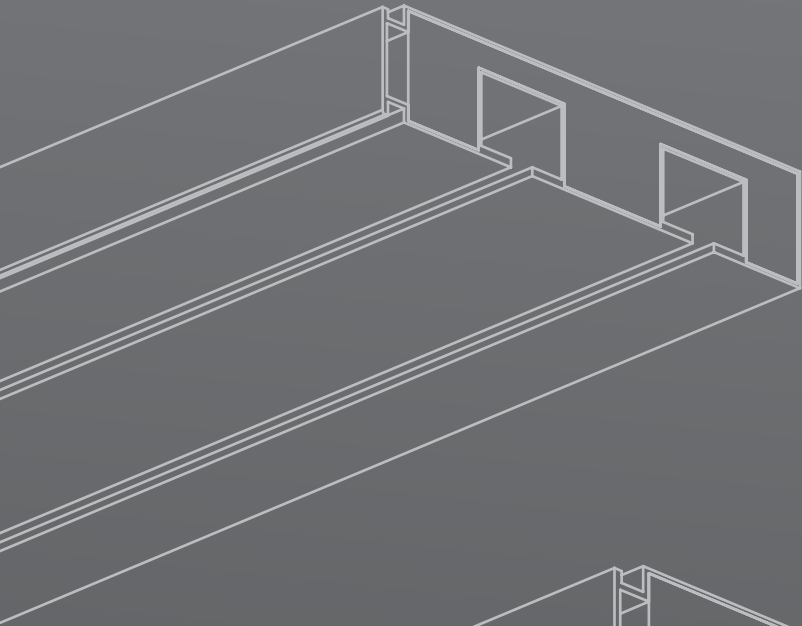

möller



SM-Plus

System 1-48

266

System 2-78

269

System 2W-88

272

System 3-88

275

Zubehör

279



Wooden- Heartware

SM-Plus steht für zeitloses Design. Durch den Holzkern erhält die Schiene eine natürliche Stärke, die besonders für schwere Stoffe hervorragend geeignet ist. Profitieren Sie von der Formstabilität, der Langlebigkeit und den guten Laufeigenschaften.

SM-plus means timeless design. Due to the wooden core the rails gain natural strength, which is excellently suited for heavy fabrics in particular. Benefit from form stability, longevity and good running properties.

System SM-PLUS

Natürliche Stärke

Durch die solide Ausführung ist SM-Plus die ideale Innenlaufschiene aus einer Kunststoff-/Holz-Kombination für hochwertige Fensterdekorationen im Privat- und Objektbereich.

Ihren Gestaltungswünschen sind keine Grenzen gesetzt. Das Zubehör umfasst Innen-, Außen- und Rundbögen sowie leicht montierbare Blenden in vielen verschiedenen Dekoren.

Natural strength

Due to the solid finish SM-plus inner rails made of a PVC/wood combination are ideally suited for high-quality window decoration in private and public sector.

There are no limits set to your creative imagination. The accessories cover inside and outside curves and arches as well as easy-to-assemble pelmets in many different decors.

KUNSTSTOFFSCHIENEN

PLASTIC RAILS

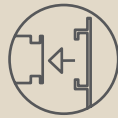

**INTEGRIERTE
BLENDENAUFNAHME**
INTEGRATED
PELMET RECEPTION



BESONDERS LEISE
EXTRA QUIET



VORGEBOHRT
PRE-DRILLED



**EINFACHES
STECKSYSTEM**
SIMPLE PLUG-IN SYSTEM



**DIVERSE
BLENDENKORE**
VARIOUS PELMET
DECORATIONS

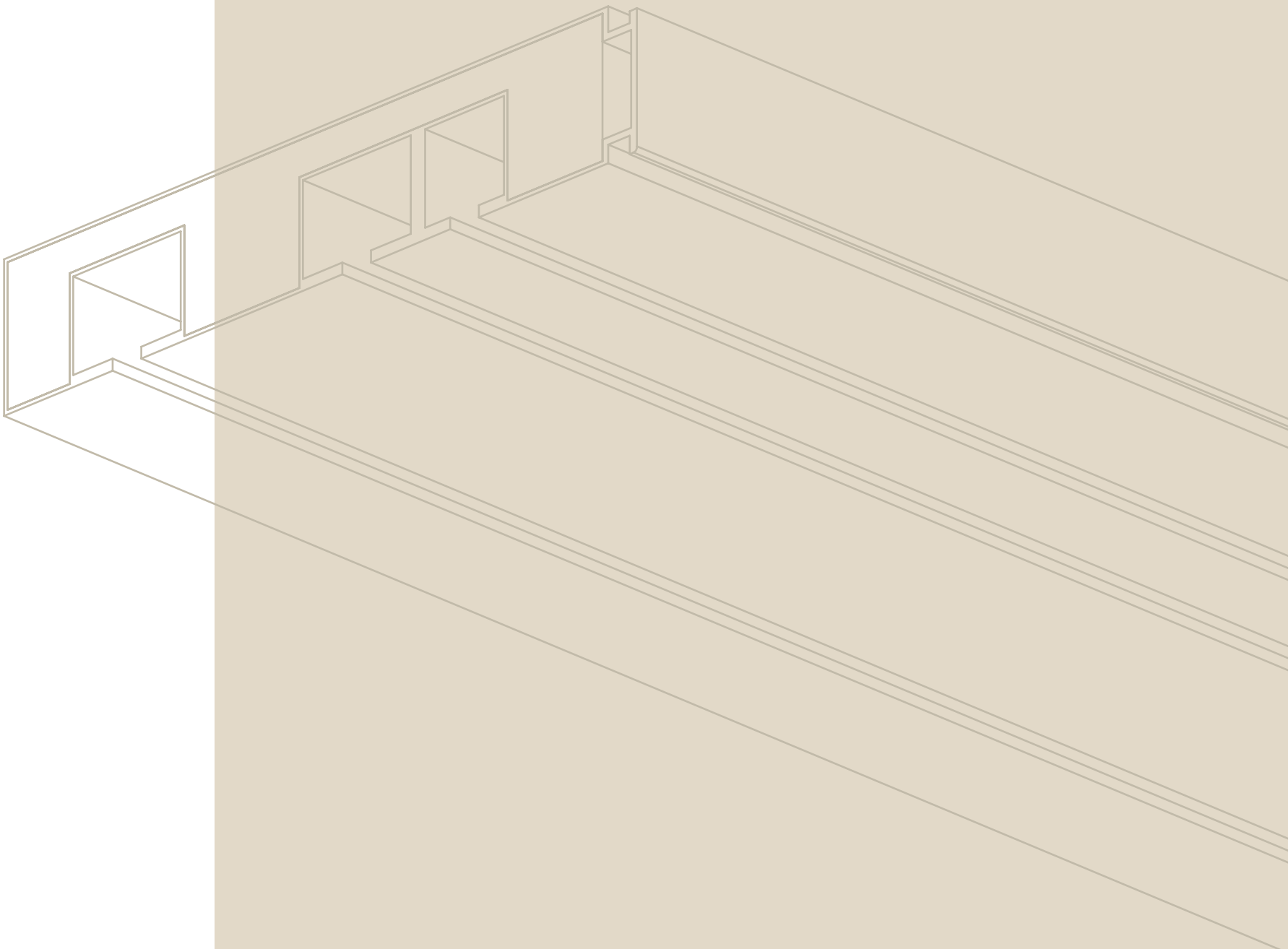

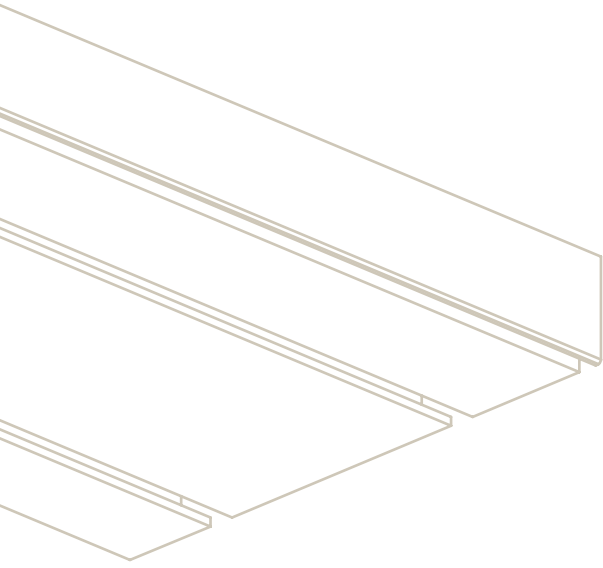

DEKORATIONS-/ EINSATZMÖGLICHKEITEN

POSSIBLE USES IN DECORATION

- als Gardinenschiene mit dekorativen Blenden für schwere, blickdichte Stoffe
- zur Gestaltung von Erkern
- als Objektschiene
- *as curtain rail with decorative cover for heavy fabrics for obscuring view*
- *for use in bay windows*
- *as rail for professional uses*



KUNSTSTOFFSCHIENEN

PLASTIC RAILS

MONTAGE

INSTALLATION

Die Deckenmontage können Sie einfach mittels vorbereiteter Bohrlöcher durchführen. Für die Wandmontage nutzen Sie unsere Winkeleisen und Brettklammen. Dekorative Aufklipsblenden in 50 mm und 75 mm Breite klipsen oder schieben Sie leicht auf die Blendenaufnahme der Vorhangschiene.

For ceiling installation you can use the pre-drilled holes. You can also use an angle metal support with board clamp for wall installation. For using decorative clip-on pelmets in widths of 50 mm and 75 mm you can clip or push it on to the front side of the curtain rail.

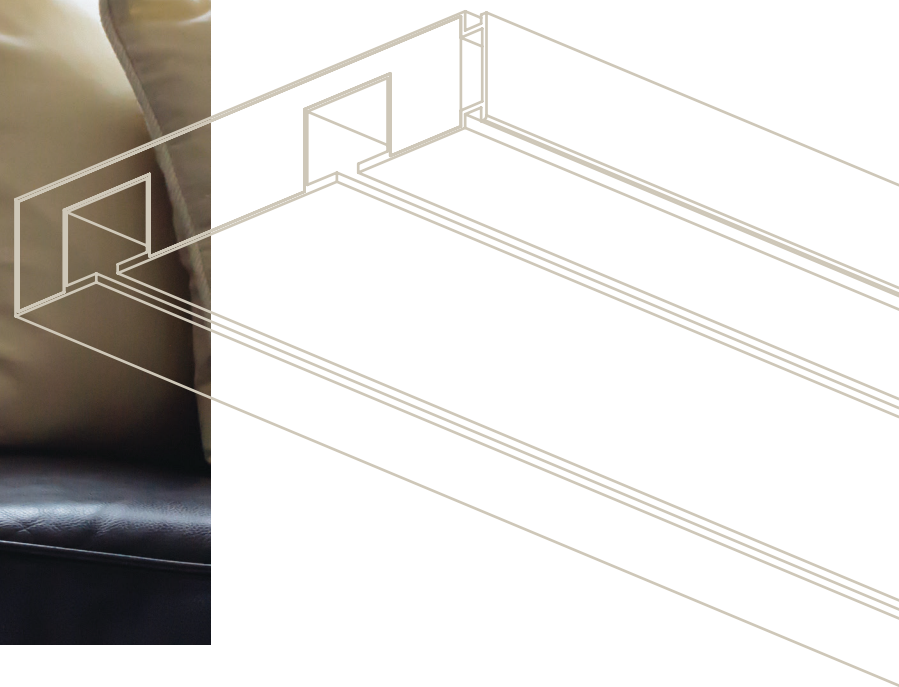

SYSTEMMERKMALE

SPECIFICATIONS

AUFBAU

MDF-Platte mit Kunststoff umspritzt,
inkl. Blendenaufnahme, vorgebohrt für
Deckenmontage im Abstand von 50 cm
bis 60 cm (je nach Schienenlänge)

STÄRKE

17 mm

LÄNGE

600 cm sowie Fixmaße für den SB-Bereich

SONDERMASSE

auf Anfrage
(Mindestmenge 100 Stück je Abmessung)

VERPACKUNG

5 Stück je Länge im Bund

FARBEN

weiß

STRUCTURE

*U-PVC covered MDF board incl. recep-
tion for pelmet; pre-drilled for ceiling
installation at distances of 50 to 60 cm
(depending on rail length)*

THICKNESS

17 mm

LENGTH

*600 cm as well as cut-to-measure sizes
for the DIY market*

SPECIAL LENGTH

*on request
(minimum 100 pieces per dimension)*

PACKING

5 pieces per length in bundle

COLOURS

white

KUNSTSTOFFSCHIENEN

PLASTIC RAILS

SCHIENENTYPEN

TYPES OF RAILS

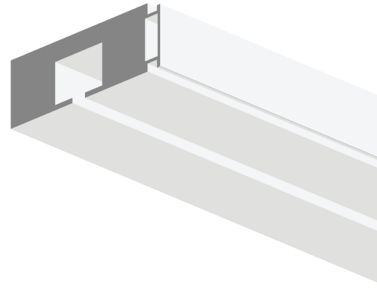

1 LAUF 1 TRACK

1-48

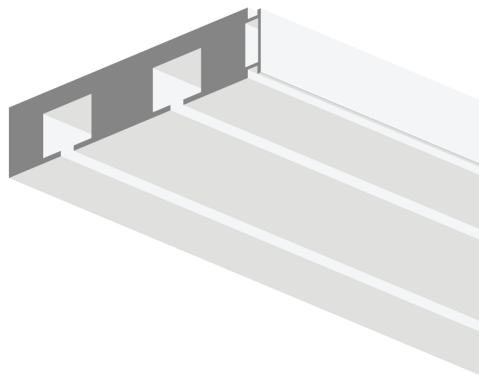

2 LAUF 2 TRACK

2-78

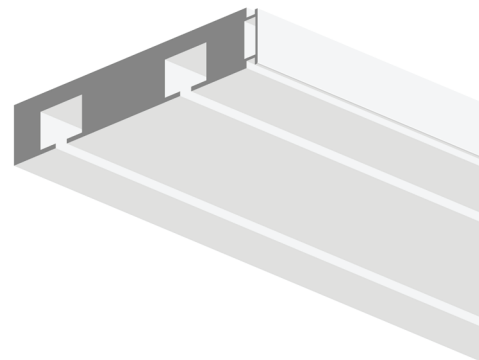

2 LAUF 2 TRACK

2W-88

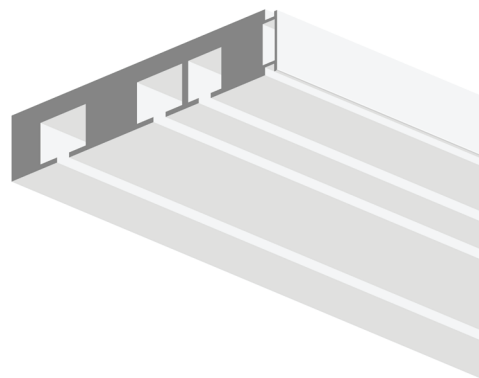

3 LAUF 3 TRACK

3-88



SCHIENEN-DEKORE

DECORS OF RAILS

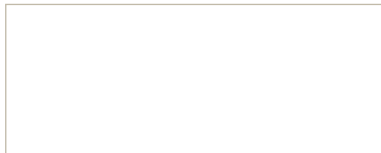

weiß / white

BLENDEN-DEKORE

DECORS OF PELMETS

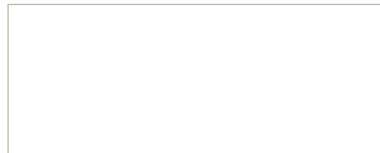

weiß / white



silber-matt / silver-matt

KUNSTSTOFFSCHIENEN

PLASTIC RAILS

BLENDEN-DEKORE (LÄNGSMASERUNG)

DECORS OF PELMETS (HORIZONTAL GRAIN)



kirschbaum / *cherry tree*

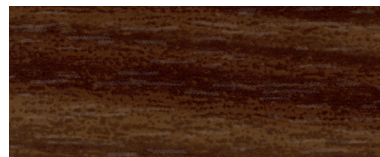

nussbaum / *walnut*

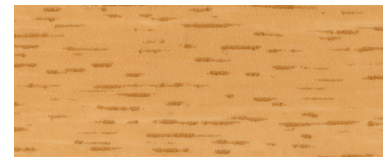

buche / *beech*

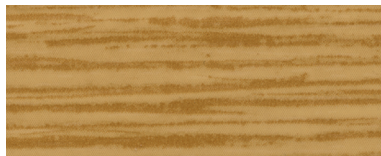

eiche-hell / *light-oak*

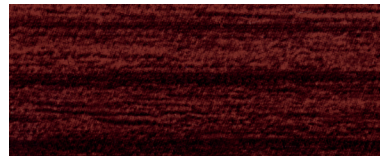

mahagoni / *mahogany*

BLENDEN-DEKORE (ANTIK)

DECORS OF PELMETS (ANTIQUÉ)



platin-antik / *platinum-antique*



kupfer-antik / *copper-antique*

SYSTEM SM-PLUS

SYSTEM 1 - 48

BEZEICHNUNG

DESCRIPTION

ARTIKEL-NR.

ARTICLE-NO.

VPE

PU

PREISEINHEIT

PRICE-UNIT

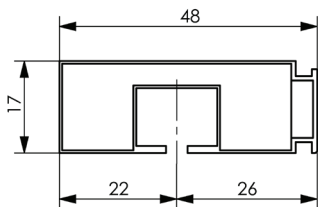

SM-Plus – Schiene 1-48

SM-Plus – rail

Länge: 600 cm

length

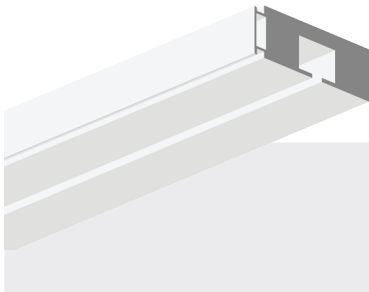

weiß / white

22 00 06

5 Längen / *lengths*

1 Meter / *meter*

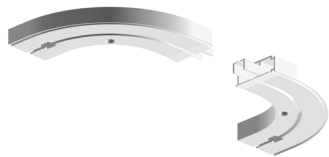

Retouren L + R 1-48

bows l + r

Länge x Breite: 130 x 130 mm

length x width

weiß / white

23 00 06

10 Paar / *pairs*

1 Paar / *pair*

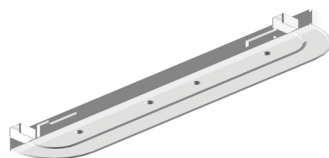

Retourenpaar – universell / rund teilbar

bow pair – universal / round can be cut to size

Länge x Breite: 400 x 60 mm

length x width

weiß / white

23 00 07

20 Stück / *pieces*

1 Stück / *piece*

KUNSTSTOFFSCHIENEN

PLASTIC RAILS

BEZEICHNUNG

DESCRIPTION

ARTIKEL-NR.

ARTICLE-NO.

VPE

PU

PREISEINHEIT

PRICE-UNIT

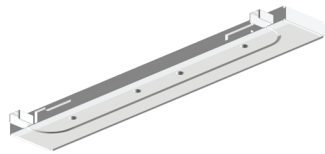

Retourenpaar – universell / eckig teilbar

*bow pair – universal / angular
can be cut to size*

Länge x Breite: 400 x 60 mm
length x width

weiß / white

23 00 08

20 Stück / pieces

1 Stück / piece

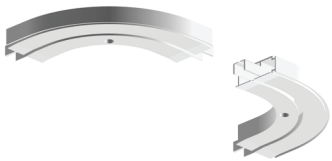

Außenbogen 1-48

outer bow

Länge x Breite: 130 x 130 mm
length x width

weiß / white

23 00 02

20 Stück / pieces

1 Stück / piece

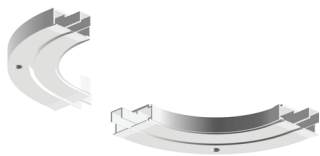

Innenbogen 1-48

inner bow

Länge x Breite: 130 x 130 mm
length x width

weiß / white

23 00 04

10 Stück / pieces

1 Stück / piece

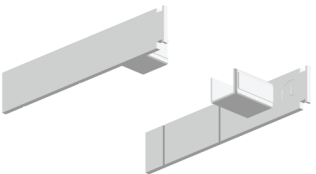

Seitendeckel L + R, Art. 600 teilbar auf 78 und 48 mm

*side cap l + r
can be cut to size to 78 and 48 mm*

weiß / white

23 00 28

100 Paar / pairs

100 Paar / pairs

SYSTEM 1 - 48

BEZEICHNUNG

DESCRIPTION

ARTIKEL-NR.

ARTICLE-NO.

VPE

PU

PREISEINHEIT

PRICE-UNIT

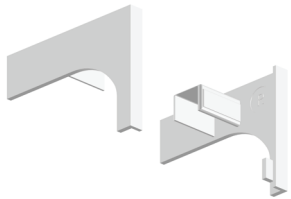

Winkelecken L + R, Art. 602

transparent

angle l + r

transparent

für 50 mm Blende /
for pelmet of 50 mm

23 00 35

100 Paar / *pairs*

100 Paar / *pairs*

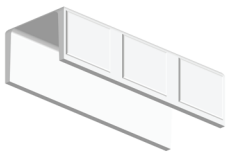

U-Verbindungszapfen

connector

transparent / transparent

23 00 33

200 Stück / *pieces*

100 Stück / *pieces*

KUNSTSTOFFSCHIENEN

PLASTIC RAILS

SYSTEM 2 - 78

BEZEICHNUNG

DESCRIPTION

ARTIKEL-NR.

ARTICLE-NO.

VPE

PU

PREISEINHEIT

PRICE-UNIT

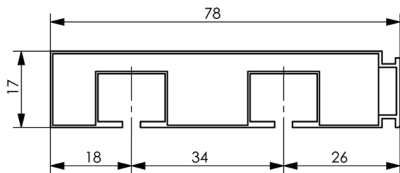

SM-Plus – Schiene 2-78

SM-Plus – rail

Länge: 600 cm

length

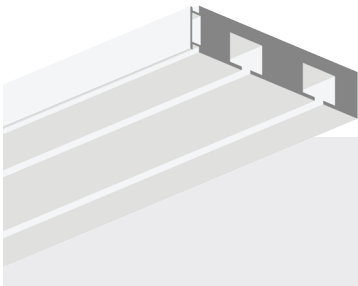

weiß / white

22 00 15

5 Längen / lengths

1 Meter / meter

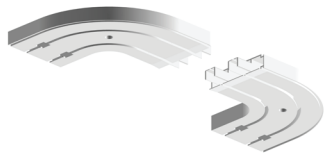

Retouren L + R 2-78

bows l + r

Länge x Breite: 150 x 150 mm

length x width

weiß / white

23 00 13

10 Paar / pairs

1 Paar / pair



Retourenpaar – universell / rund teilbar

bow pair – universal / round can be cut to size

Länge x Breite: 400 x 60 mm

length x width

weiß / white

23 00 07

20 Stück / pieces

1 Stück / piece

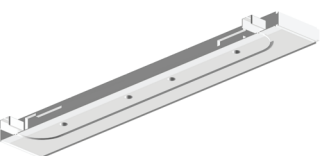

Retourenpaar – universell / eckig teilbar

bow pair – universal / angular can be cut to size

Länge x Breite: 400 x 60 mm

length x width

weiß / white

23 00 08

20 Stück / pieces

1 Stück / piece

SYSTEM 2 - 78

BEZEICHNUNG

DESCRIPTION

ARTIKEL-NR.

ARTICLE-NO.

VPE

PU

PREISEINHEIT

PRICE-UNIT

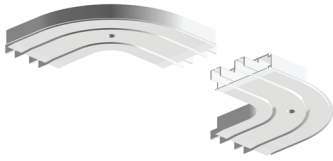

Außenbogen 2-78

outer bow

Länge x Breite: 150 x 150 mm

length x width

weiß / white

23 00 09

20 Stück / pieces

1 Stück / piece

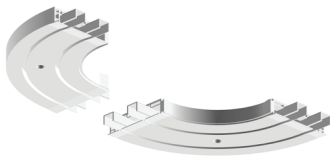

Innenbogen 2-78

inner bow

Länge x Breite: 155 x 155 mm

length x width

weiß / white

23 00 11

10 Stück / pieces

1 Stück / piece

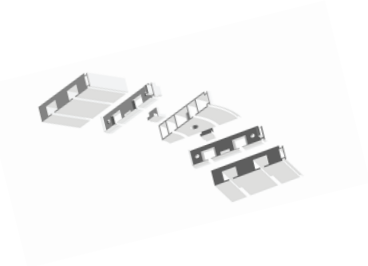

**Außenbogen 2-78
mit Gradeinteilung**

*outer bow
with graduation*

weiß / white

23 00 10

20 Stück / pieces

1 Stück / piece



**Innenbogen 2-78
mit Gradeinteilung**

*inner bow
with graduation*

weiß / white

23 00 12

10 Stück / pieces

1 Stück / piece

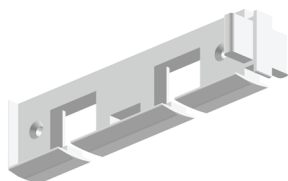

**Adapter für Bögen 2-78
mit Gradeinteilung**

*adapter for bows
with graduation*

weiß / white

23 00 38

50 Stück / pieces

1 Stück / piece

KUNSTSTOFFSCHIENEN

PLASTIC RAILS

BEZEICHNUNG

DESCRIPTION

ARTIKEL-NR.

ARTICLE-NO.

VPE

PU

PREISEINHEIT

PRICE-UNIT

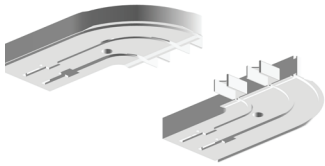

Retouren L + R / klein 2-78

bows l + r / small

Länge x Breite: 150 x 68 mm

length x width

weiß / white

23 00 14

10 Paar / pairs

1 Paar / pair

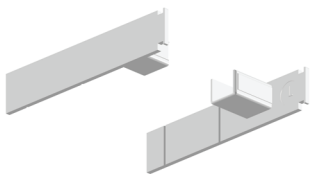

Seitendeckel L + R, Art. 600 teilbar auf 78 und 48 mm

side cap l + r

can be cut to size to 78 and 48 mm

weiß / white

23 00 28

100 Paar / pairs

100 Paar / pairs

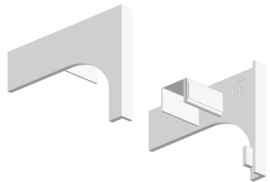

Winkelecken L + R, Art. 602 transparent

angle l + r

transparent

für 50 mm Blende /
for pelmet of 50 mm

23 00 35

100 Paar / pairs

100 Paar / pairs

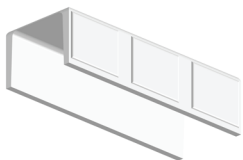

U-Verbindungszapfen

connector

transparent / transparent

23 00 33

200 Stück / pieces

100 Stück / pieces

SYSTEM SM-PLUS

SYSTEM 2W - 88

BEZEICHNUNG

DESCRIPTION

ARTIKEL-NR.

ARTICLE-NO.

VPE

PU

PREISEINHEIT

PRICE-UNIT

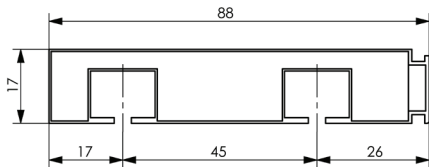

SM-Plus – Schiene 2W-88

SM-Plus – rail

Länge: 600 cm

length

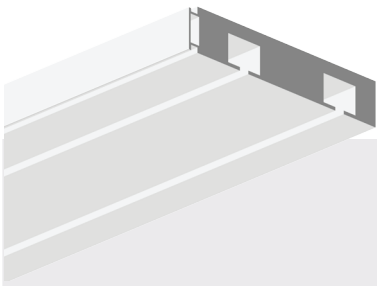

weiß / white

22 00 21

5 Längen / lengths

1 Meter / meter

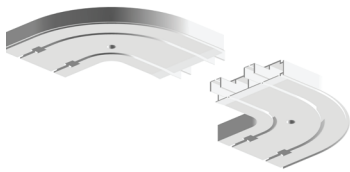

Retouren L + R 2W-88

bows l + r

Länge x Breite: 150 x 150 mm

length x width

weiß / white

23 00 19

10 Paar / pairs

1 Paar / pair

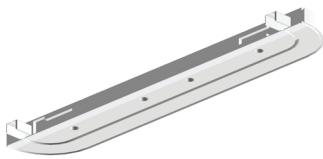

Retourenpaar – universell / rund teilbar

bow pair – universal / round
can be cut to size

Länge x Breite: 400 x 60 mm

length x width

weiß / white

23 00 07

20 Stück / pieces

1 Stück / piece

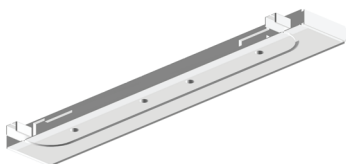

Retourenpaar – universell / eckig teilbar

bow pair – universal / angular
can be cut to size

Länge x Breite: 400 x 60 mm

length x width

weiß / white

23 00 08

20 Stück / pieces

1 Stück / piece

KUNSTSTOFFSCHIENEN

PLASTIC RAILS

BEZEICHNUNG

DESCRIPTION

ARTIKEL-NR.

ARTICLE-NO.

VPE

PU

PREISEINHEIT

PRICE-UNIT

Außenbogen 2W-88

outer bow

Länge x Breite: 150 x 150 mm

length x width

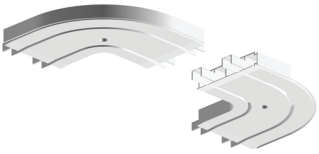

weiß / white

23 00 15

20 Stück / pieces

1 Stück / piece

Innenbogen 2W-88

inner bow

Länge x Breite: 165 x 165 mm

length x width

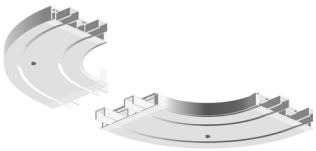

weiß / white

23 00 17

10 Stück / pieces

1 Stück / piece

Außenbogen 2W-88 mit Gradeinteilung

outer bow

with graduation

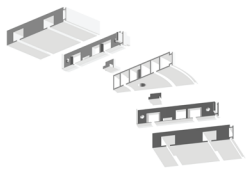

weiß / white

23 00 16

20 Stück / pieces

1 Stück / piece

Adapter 2W-88 für Bögen mit Gradeinteilung

adapter for bows

with graduation

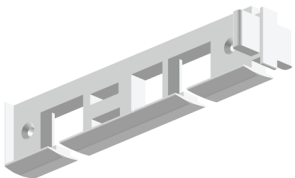

weiß / white

23 00 39

50 Stück / pieces

1 Stück / piece

SYSTEM 2W - 88

BEZEICHNUNG

DESCRIPTION

ARTIKEL-NR.

ARTICLE-NO.

VPE

PU

PREISEINHEIT

PRICE-UNIT

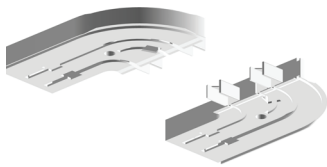

Retouren L + R / klein 2W-88

bows l + r / small

Länge x Breite: 150 x 68 mm

length x width

weiß / white

23 00 25

10 Paar / pairs

1 Paar / pair

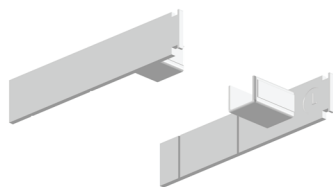

**Seitendeckel L + R, Art. 600
teilbar auf 78 und 48 mm**

side cap l + r

can be cut to size to 78 and 48 mm

weiß / white

23 00 28

100 Paar / pairs

100 Paar / pairs

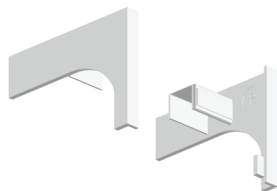

**Winkelecken L + R, Art. 602
transparent**

angle l + r

transparent

**für 50 mm Blende /
for pelmet of 50 mm**

23 00 35

100 Paar / pairs

100 Paar / pairs

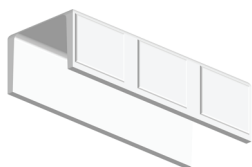

U-Verbindungszapfen

connector

transparent / transparent

23 00 33

200 Stück / pieces

100 Stück / pieces

KUNSTSTOFFSCHIENEN

PLASTIC RAILS

SYSTEM 3 - 88

BEZEICHNUNG

DESCRIPTION

ARTIKEL-NR.

ARTICLE-NO.

VPE

PU

PREISEINHEIT

PRICE-UNIT

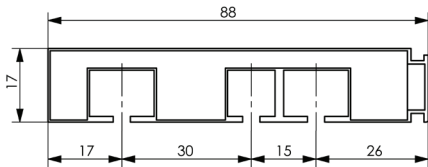

SM-Plus – Schiene 3-88

SM-Plus – rail

Länge: 600 cm

length

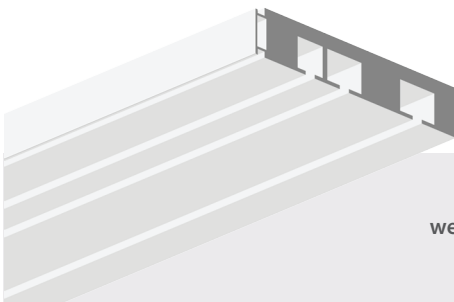

weiß / white

22 00 29

5 Längen / lengths

1 Meter / meter

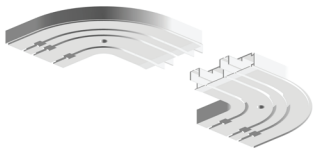

Retouren L + R 3-88

bows l + r

Länge x Breite: 150 x 150 mm

length x width

weiß / white

23 00 24

10 Paar / pairs

1 Paar / pair



Retourenpaar – universell / rund teilbar

bow pair – universal / round
can be cut to size

Länge x Breite: 400 x 60 mm

length x width

weiß / white

23 00 07

20 Stück / pieces

1 Stück / piece

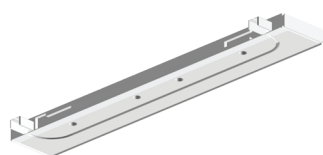

Retourenpaar – universell / eckig teilbar

bow pair – universal / angular
can be cut to size

Länge x Breite: 400 x 60 mm

length x width

weiß / white

23 00 08

20 Stück / pieces

1 Stück / piece

SYSTEM 3 - 88

BEZEICHNUNG

DESCRIPTION

ARTIKEL-NR.

ARTICLE-NO.

VPE

PU

PREISEINHEIT

PRICE-UNIT

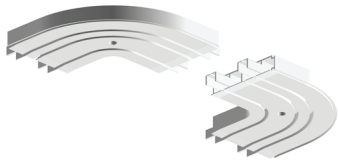

Außenbogen 3-88

outer bow

Länge x Breite: 150 x 150 mm

length x width

weiß / white

23 00 20

20 Stück / pieces

1 Stück / piece

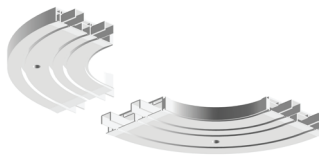

Innenbogen 3-88

inner bow

Länge x Breite: 165 x 165 mm

length x width

weiß / white

23 00 22

10 Stück / pieces

1 Stück / piece

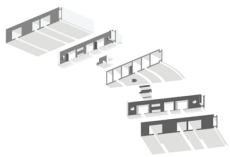

**Außenbogen 3-88
mit Gradeinteilung**

*outer bow
with graduation*

weiß / white

23 00 21

20 Stück / pieces

1 Stück / piece



**Innenbogen 3-88
mit Gradeinteilung**

*inner bow
with graduation*

weiß / white

23 00 23

10 Stück / pieces

1 Stück / piece

KUNSTSTOFFSCHIENEN

PLASTIC RAILS

BEZEICHNUNG

DESCRIPTION

ARTIKEL-NR.

ARTICLE-NO.

VPE

PU

PREISEINHEIT

PRICE-UNIT



Adapter 3-88
für Bögen mit Gradeinteilung
adapter for bows
with graduation

weiß / white

23 00 39

50 Stück / pieces

1 Stück / piece

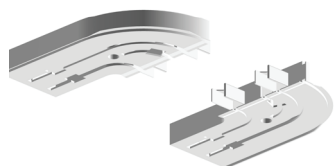

Retouren L + R / klein 3-88
bows l + r / small

Länge x Breite: 150 x 68 mm
length x width

weiß / white

23 00 25

10 Paar / pairs

1 Paar / pair

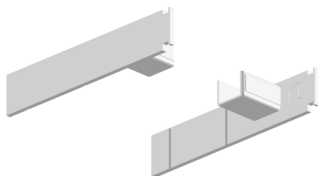

Seitendeckel L + R, Art. 600
teilbar auf 78 und 48 mm
side cap l + r
can be cut to size to 78 and 48 mm

weiß / white

23 00 28

100 Paar / pairs

100 Paar / pairs

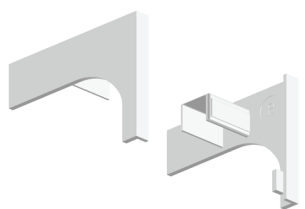

Winkelecken L + R, Art. 602
transparent
angle l + r
transparent

für 50 mm Blende /
for pelmet of 50 mm

23 00 35

100 Paar / pairs

100 Paar / pairs

SYSTEM 3 - 88

BEZEICHNUNG

DESCRIPTION

ARTIKEL-NR.

ARTICLE-NO.

VPE

PU

PREISEINHEIT

PRICE-UNIT

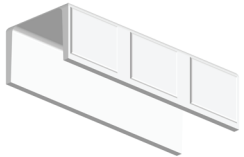

U-Verbindungszapfen

connector

transparent / transparent

23 00 33

200 Stück / *pieces*

100 Stück / *pieces*

KUNSTSTOFFSCHIENEN

PLASTIC RAILS

ZUBEHÖR

BEZEICHNUNG

DESCRIPTION

ARTIKEL-NR.

ARTICLE-NO.

VPE

PU

PREISEINHEIT

PRICE-UNIT



Aufklipsblende

in Ringen à 50 m

plug-in pelmet
in rings with 50 m

50 mm breit

50 mm wide

weiß / white	45 00 19	50 Meter / meters	100 Meter / meters
kirschbaum / cherry tree	45 00 22	50 Meter / meters	100 Meter / meters
eiche-hell / light oak	45 00 26	50 Meter / meters	100 Meter / meters
mahagoni / mahogany	45 00 36	50 Meter / meters	100 Meter / meters
buche / beech	45 00 39	50 Meter / meters	100 Meter / meters
nussbaum / walnut	45 00 63	50 Meter / meters	100 Meter / meters
silber-matt / silver matt	45 00 41	50 Meter / meters	100 Meter / meters
platin-antik / platinum-antique	45 00 78	50 Meter / meters	100 Meter / meters
kupfer-antik / copper-antique	45 00 79	50 Meter / meters	100 Meter / meters

75 mm breit

75 mm wide

weiß / white	45 00 20	50 Meter / meters	100 Meter / meters
---------------------	-----------------	-------------------	--------------------



Faltenleggleiter, Art. 603

fold glider

49 00 03	1.000 Stück / pieces	100 Stück / pieces
-----------------	----------------------	--------------------



Faltenleg- Schleuderwagen, Art. 612 K

fold flinging glider

Kugelrolle 8 mm Ø	49 00 20	200 Stück / pieces	100 Stück / pieces
<i>ball roll</i>			

ZUBEHÖR

BEZEICHNUNG

DESCRIPTION

ARTIKEL-NR.

ARTICLE-NO.

VPE

PU

PREISEINHEIT

PRICE-UNIT

**Faltenleg-Rolle, Art. 613 K***fold roll***Kugelrolle 8 mm Ø***ball roll***49 00 23**1.000 Stück / *pieces*100 Stück / *pieces***Zwischenfeststeller, Art. 609***intermediate stop***49 00 06**500 Stück / *pieces*100 Stück / *pieces***Endfeststeller, Art. 618****vierkant***end stop**square***49 00 27**500 Stück / *pieces*100 Stück / *pieces***Universal-
Endfeststeller, Art. 619***universal end stop***49 00 28**500 Stück / *pieces*100 Stück / *pieces***Universal-
End- /
Zwischenfeststeller, Art. 621***universal end- /**intermediate stop***49 00 29**500 Stück / *pieces*100 Stück / *pieces*

KUNSTSTOFFSCHIENEN

PLASTIC RAILS

BEZEICHNUNG

DESCRIPTION

ARTIKEL-NR.

ARTICLE-NO.

VPE

PU

PREISEINHEIT

PRICE-UNIT

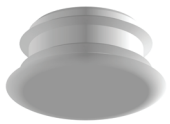

Abdeckstopfen, Art. 610

9 mm Ø

plastic plug

9 mm Ø

weiß / white

49 00 08

2.000 Stück / pieces

1.000 Stück / pieces



Brettklemme, Art. 629

verzinkt, 35 mm lang

rail holder

zinc, 35 mm long

51 00 01

100 Stück / pieces

100 Stück / pieces



Winkelträger 3,5 mm

gelocht

angle bracket 3.5 mm

punched

60 x 120 mm grau / grey

51 00 23

50 Stück / pieces

100 Stück / pieces

60 x 160 mm grau / grey

51 00 25

50 Stück / pieces

100 Stück / pieces

60 x 200 mm grau / grey

51 00 27

50 Stück / pieces

100 Stück / pieces

60 x 120 mm weiß / white

51 00 24

50 Stück / pieces

100 Stück / pieces

60 x 160 mm weiß / white

51 00 26

50 Stück / pieces

100 Stück / pieces

60 x 200 mm weiß / white

51 00 28

50 Stück / pieces

100 Stück / pieces

Ausklinkwerkzeug, Art. 633

vierkant

10,5 x 12,0 mm

punching tool

square

10,5 x 12,0 mm

51 00 19

1 Stück / piece

1 Stück / piece

ZUBEHÖR

BEZEICHNUNG

DESCRIPTION

ARTIKEL-NR.

ARTICLE-NO.

VPE

PU

PREISEINHEIT

PRICE-UNIT



**Stufenbohrer, Art. 638
mit Zentrierspitze**
*stepping drill
with centre point*

6,2 mm / 8,8 mm

51 00 20

1 Stück / *piece*

1 Stück / *piece*



Gleitfix-Sprühmittel
silicone lubricant

Größe 1 / size 1

75 ml

51 00 02

12 Dosen / *cans*

1 Dose / *can*

Größe 2 / size 2

150 ml

51 00 03

12 Dosen / *cans*

1 Dose / *can*

Größe 3 / size 3

400 ml

51 00 04

12 Dosen / *cans*

1 Dose / *can*



Sekundenkleber
rapid setting glue

Tube à 3 g / tube of 3 g

51 00 22

10 Stück / *pieces*

1 Stück / *piece*

SYSTEM CM

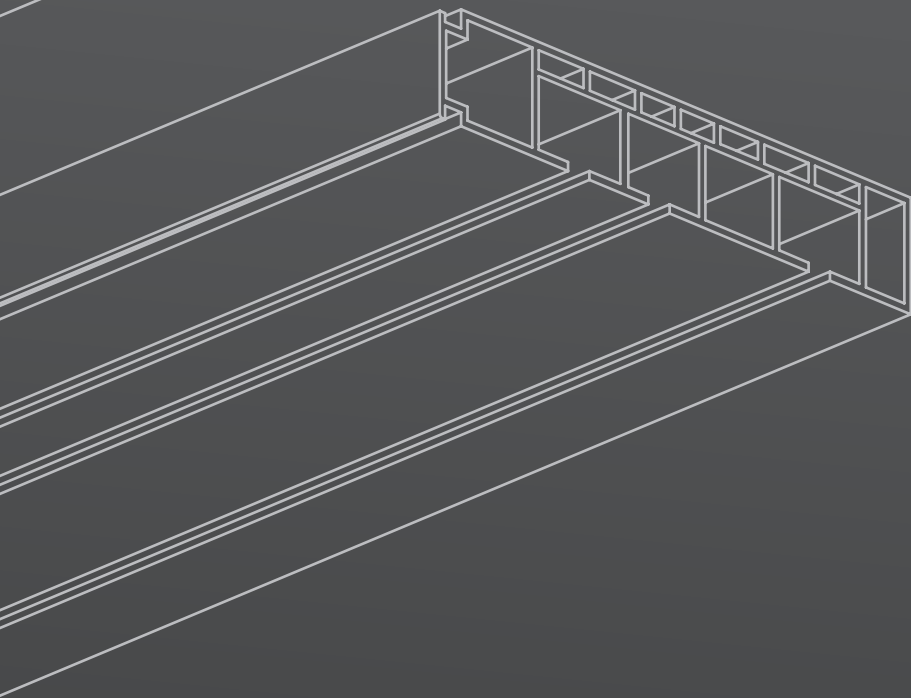
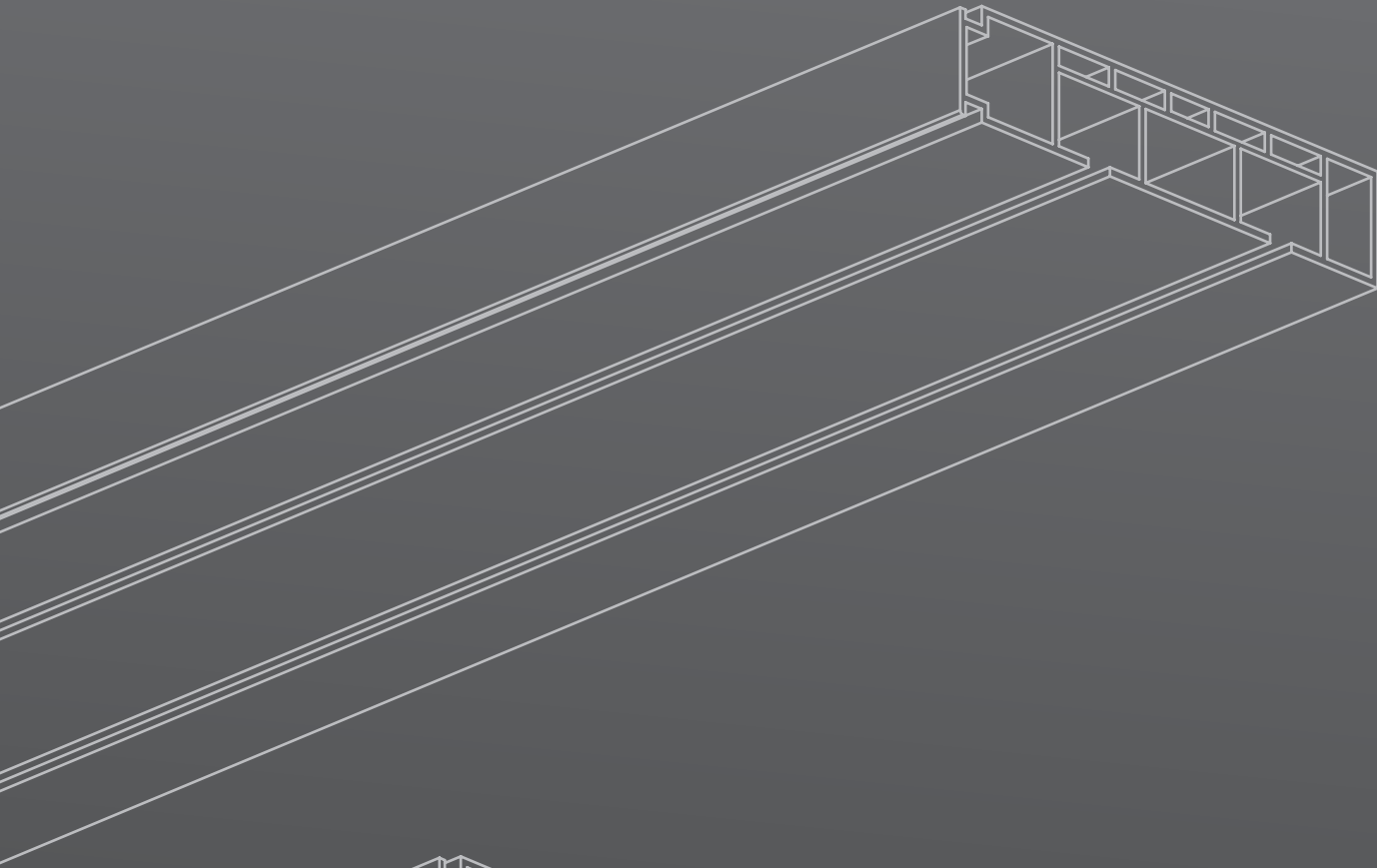

möller

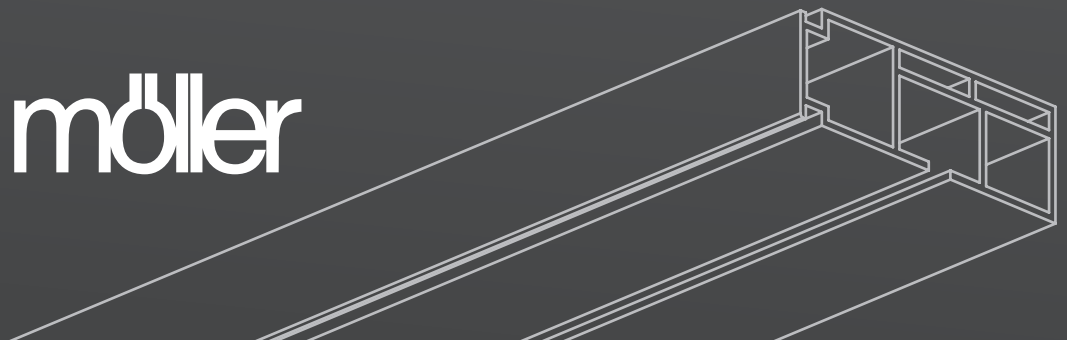

System CM

System 1-48

298

System 2-78

301

System 3-88

304

System 3-112

307

Zubehör

309

Leicht montiertes Leichtgewicht

Die intelligente Profilgeometrie in Kombination mit der Leichtigkeit verleiht der Schiene ausgezeichnete Produkteigenschaften bei optimalem Preis-Leistungsverhältnis.

Intelligent profile geometry in combination with ease give excellent product characteristics to this rail at optimum cost-performance ratio.

KUNSTSTOFFSCHIENEN

PLASTIC RAILS



System CM

Die Profi-Schiene in leichter Ausführung

Die CM-Schiene ist ideal geeignet für den Einsatz im Privat- und Objektbereich.

Mit dem umfangreichen Sortiment an Bogenelementen lässt sich die 17 mm hohe Innenlaufschiene aus Kunststoff vielseitig kombinieren. Speziell für den Einsatz von Verdunklungsstoffen ist der Schientyp CM 3-112 geeignet.

Professional rail in light version

The CM rail is ideally suited to be used in private and public sector.

Due to the extensive range of curve elements, this plastic inner-track rail (17 mm in height) can be combined in a versatile way.

The CM 3-112 rail model is especially suited for using blackout fabrics.

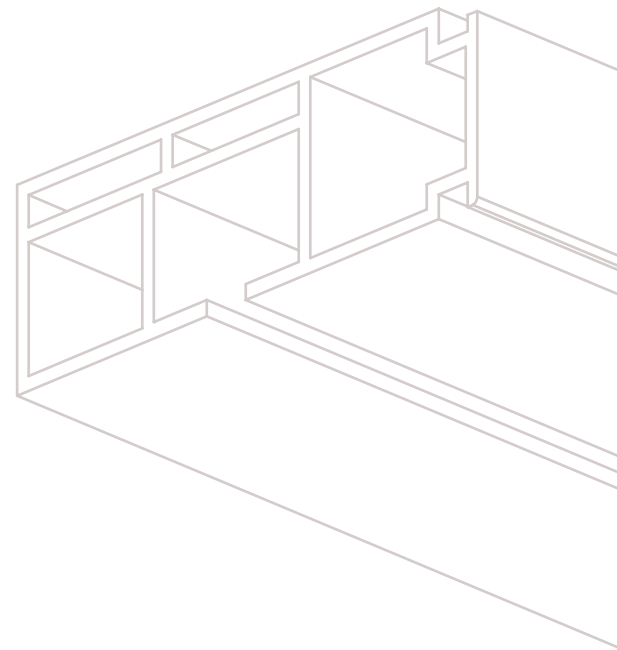

KUNSTSTOFFSCHIENEN

PLASTIC RAILS



**INTEGRIERTE
BLENDENAUFNAHME**
*INTEGRATED
PELMET RECEPTION*



**VIelfÄLTIGES
BOGENZUBEHÖR**
*A GREAT VARIETY
OF BOW ACCESSORIES*



VORGEBOHRT
PRE-DRILLED



**EINFACHES
STECKSYSTEM**
SIMPLE PLUG-IN SYSTEM



**DIVERSE
BLENDENDEKORE**
*VARIOUS
PELMET DECORATIONS*



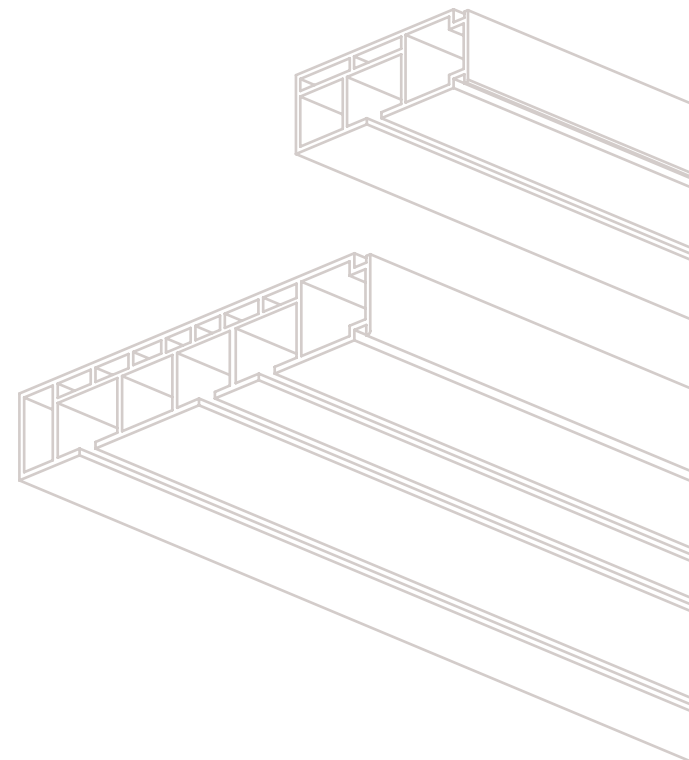

DEKORATIONS-/ EINSATZMÖGLICHKEITEN

POSSIBLE USES IN DECORATION

- als Gardinenschiene mit dekorativer Blende für leichte und transparente Stoffe
- zur Gestaltung von Erkern
- als Objektschiene für Verdunkelungen
- Durch den Einsatz eines Adapters für den Innenlauf kann die CM-Schiene mit der Raffvorhang-Technik kombiniert werden (siehe System Aluminium, Rubrik Raffvorhang)
- Durch den Einsatz des Kunststoff-paneelwagens kann die CM-Schiene als Flächenvorhangschiene genutzt werden
- *as a curtain rail with decorative pelmet for lightweight transparent fabrics*
- *for bay windows*
- *as object rail for darkening*
- *by using an adapter for the inner track, it is possible to combine the CM rail with the roman blind technology (see Aluminium System, roman blind systems)*
- *by using the plastic panel track, the CM rail can be formed into panel curtain*

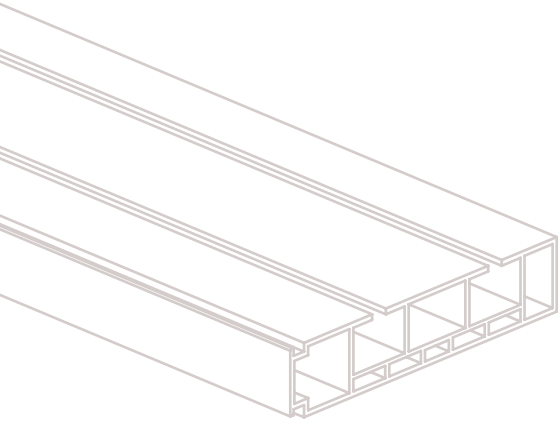

MONTAGE

INSTALLATION

- Die Deckenmontage erfolgt durch die vorbereiteten Bohrlöcher
- Die Wandmontage erfolgt mit Brettklemme und Winkeleisen
- Dekorative Aufklipsblenden in 50 mm und 75 mm Breite werden auf die Blendenaufnahme der Vorhangschiene geklippt oder geschoben
- *ceiling installation possible with pre-drilled holes*
- *wall installation with board clamp and angle steel support*
- *decorative clip-on pelmets in widths of 50 mm and 75 mm are clipped or pushed on to the cover holder of the curtain rail*



KUNSTSTOFFSCHIENEN

PLASTIC RAILS



SCHIENENTYPEN

TYPES OF RAILS

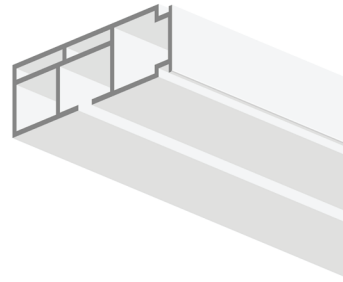

1 LAUF 1 TRACK

1-48

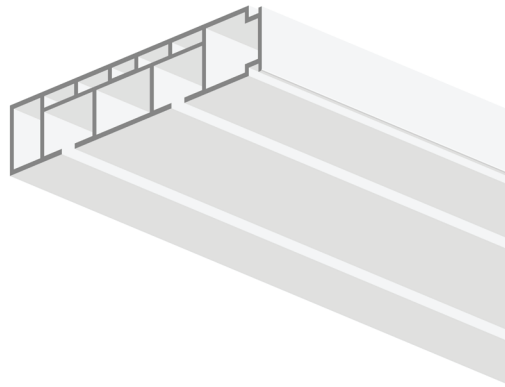

2 LAUF 2 TRACK

2-78

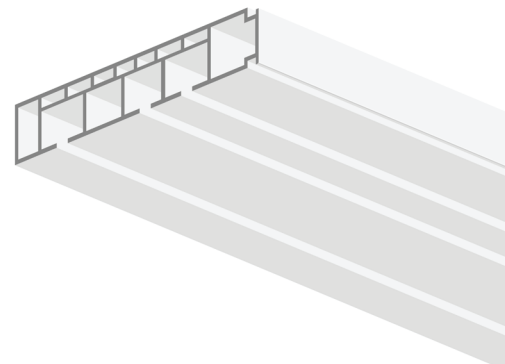

3 LAUF 3 TRACK

3-88

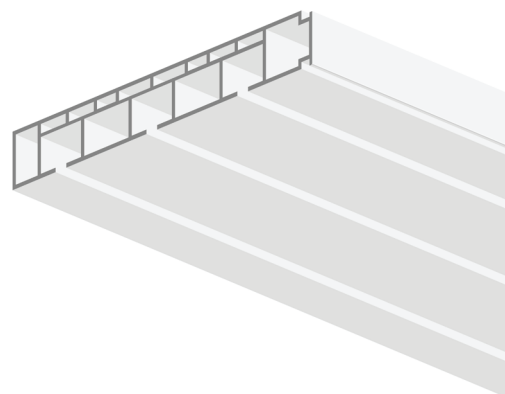

3 LAUF 3 TRACK

3-112

KUNSTSTOFFSCHIENEN

PLASTIC RAILS

SYSTEMMERKMALE

SPECIFICATIONS

AUFBAU

Kunststoffprofil mit Blendenaufnahme;
vorgebohrt für Deckenmontage im Abstand
von 50 cm bis 60 cm (je nach Schienenlänge)

STÄRKE

17 mm

LÄNGE

600 cm sowie Fixmaße für den SB-Bereich

SONDERMASSE

auf Anfrage
(Mindestmenge 100 Stück je Abmessung)

VERPACKUNG

5 Stück je Länge im Bund

FARBEN

weiß

STRUCTURE

PVC profile with reception for pelmet; pre-drilled for
ceiling installation at distances of 50 to 60 cm
(depending on rail length)

THICKNESS

17 mm

LENGTH

600 cm as well as cut-to-measure sizes for the DIY market

SPECIAL LENGTH

on request
(minimum 100 pieces per dimension)

PACKING

5 pieces per length in bundle

COLOURS

white



SCHIENEN-DEKORE

DECORS OF RAILS

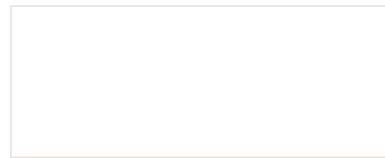

weiß / white

BLENDEN-DEKORE

DECORS OF PELMETS

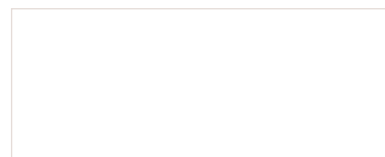

weiß / white



silber-matt / silver-matt

KUNSTSTOFFSCHIENEN

PLASTIC RAILS

BLENDEN-DEKORE (LÄNGSMASERUNG)

DECORS OF PELMETS (HORIZONTAL GRAIN)



kirschbaum / *cherry tree*

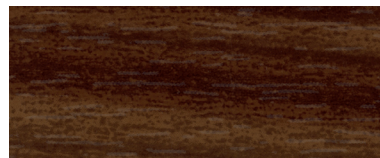

nussbaum / *walnut*

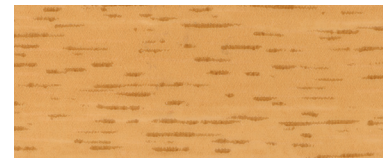

buche / *beech*

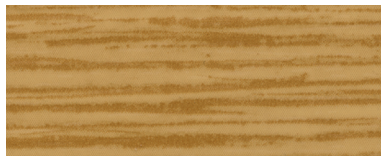

eiche-hell / *light-oak*

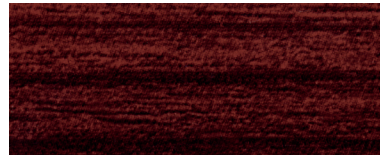

mahagoni / *mahogany*

BLENDEN-DEKORE (ANTIK)

DECORS OF PELMETS (ANTIQUÉ)



platin-antik / *platinum-antique*

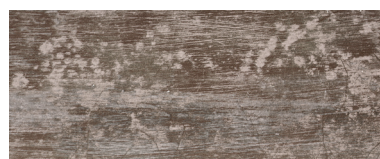

kupfer-antik / *copper-antique*

SYSTEM CM

SYSTEM 1 - 48

BEZEICHNUNG

DESCRIPTION

ARTIKEL-NR.

ARTICLE-NO.

VPE

PU

PREISEINHEIT

PRICE-UNIT

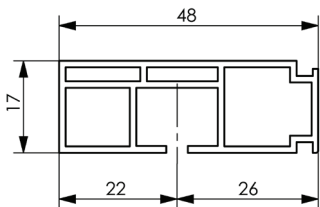

CM - Schiene 1-48

CM - rail

Länge: 600 cm

length

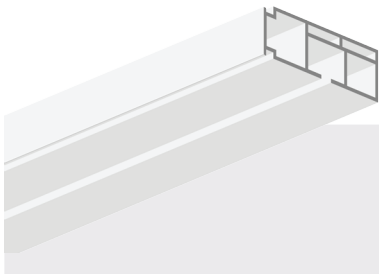

weiß / white

41 00 10

5 Längen / lengths

1 Meter / meter



Retouren L + R 1-48

bows l + r

Länge x Breite: 130 x 130 mm

length x width

weiß / white

23 00 06

10 Paar / pairs

1 Paar / pair

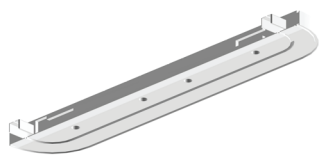

Retourenpaar - universell / rund teilbar

bow pair - universal / round
can be cut to size

Länge x Breite: 400 x 60 mm

length x width

weiß / white

23 00 07

20 Stück / pieces

1 Stück / piece



Retourenpaar - universell / eckig teilbar

bow pair - universal / angular
can be cut to size

Länge x Breite: 400 x 60 mm

length x width

weiß / white

23 00 08

20 Stück / pieces

1 Stück / piece

KUNSTSTOFFSCHIENEN

PLASTIC RAILS

BEZEICHNUNG

DESCRIPTION

ARTIKEL-NR.

ARTICLE-NO.

VPE

PU

PREISEINHEIT

PRICE-UNIT

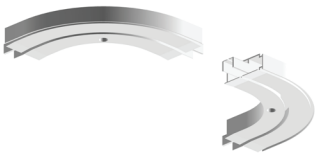

Außenbogen 1-48

outer bow

Länge x Breite: 130 x 130 mm

length x width

weiß / white

23 00 02

20 Stück / pieces

1 Stück / piece

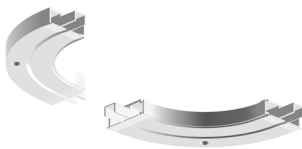

Innenbogen 1-48

inner bow

Länge x Breite: 130 x 130 mm

length x width

weiß / white

23 00 04

10 Stück / pieces

1 Stück / piece

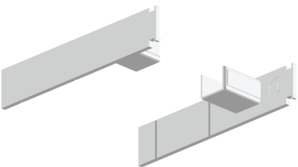

Seitendeckel L + R, Art. 600

teilbar auf 78 und 48 mm

side cap l + r

can be cut to size to 78 and 48 mm

weiß / white

23 00 28

100 Paar / pairs

100 Paar / pairs

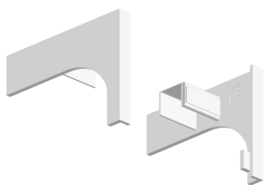

Winkelecken L + R, Art. 602

transparent

angle l + r

transparent

für 50 mm Blende /
for pelmet of 50 mm

23 00 35

100 Paar / pairs

100 Paar / pairs

SYSTEM 1 - 48

BEZEICHNUNG

DESCRIPTION

ARTIKEL-NR.

ARTICLE-NO.

VPE

PU

PREISEINHEIT

PRICE-UNIT

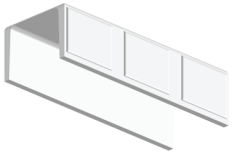

U-Verbindungzapfen

connector

transparent / transparent

23 00 33

200 Stück / *pieces*

100 Stück / *pieces*

KUNSTSTOFFSCHIENEN

PLASTIC RAILS

SYSTEM 2 - 78

BEZEICHNUNG

DESCRIPTION

ARTIKEL-NR.

ARTICLE-NO.

VPE

PU

PREISEINHEIT

PRICE-UNIT

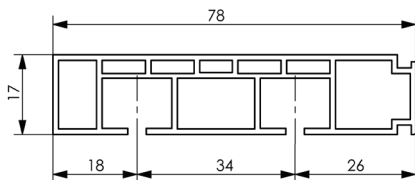

CM – Schiene 2-78

CM – rail

Länge: 600 cm

length

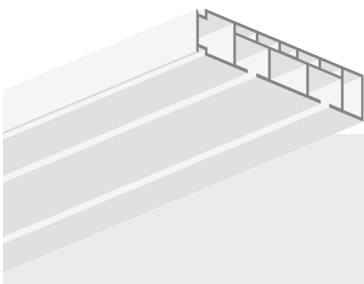

weiß / white

41 00 22

5 Längen / lengths

1 Meter / meter

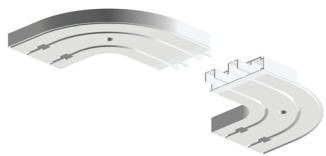

Retouren L + R 2-78

bows l + r

Länge x Breite: 150 x 150 mm

length x width

weiß / white

23 00 13

10 Paar / pairs

1 Paar / pair



Retourenpaar – universell / rund teilbar

bow pair – universal / round
can be cut to size

Länge x Breite: 400 x 60 mm

length x width

weiß / white

23 00 07

20 Stück / pieces

1 Stück / piece

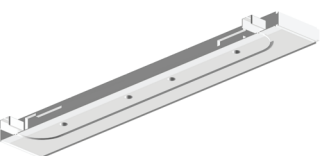

Retourenpaar – universell / eckig teilbar

bow pair – universal / angular
can be cut to size

Länge x Breite: 400 x 60 mm

length x width

weiß / white

23 00 08

20 Stück / pieces

1 Stück / piece

SYSTEM 2 - 78

BEZEICHNUNG

DESCRIPTION

ARTIKEL-NR.

ARTICLE-NO.

VPE

PU

PREISEINHEIT

PRICE-UNIT

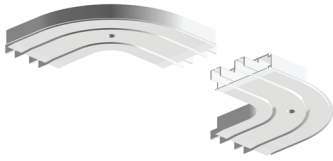

Außenbogen 2-78

outer bow

Länge x Breite: 150 x 150 mm

length x width

weiß / white

23 00 09

20 Stück / pieces

1 Stück / piece

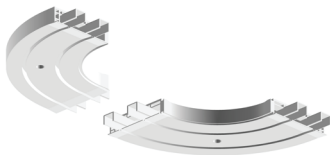

Innenbogen 2-78

inner bow

Länge x Breite: 155 x 155 mm

length x width

weiß / white

23 00 11

10 Stück / pieces

1 Stück / piece

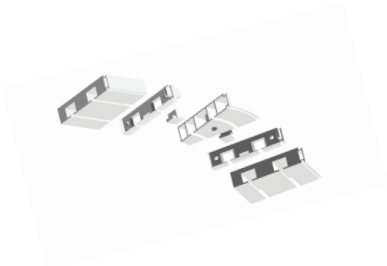

**Außenbogen 2-78
mit Gradeinteilung**

*outer bow
with graduation*

weiß / white

23 00 10

20 Stück / pieces

1 Stück / piece



**Innenbogen 2-78
mit Gradeinteilung**

*inner bow
with graduation*

weiß / white

23 00 12

10 Stück / pieces

1 Stück / piece



**Adapter 2-78
für Bögen mit Gradeinteilung**

*adapter for bows
with graduation*

weiß / white

23 00 38

50 Stück / pieces

1 Stück / piece

KUNSTSTOFFSCHIENEN

PLASTIC RAILS

BEZEICHNUNG

DESCRIPTION

ARTIKEL-NR.

ARTICLE-NO.

VPE

PU

PREISEINHEIT

PRICE-UNIT

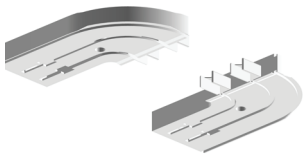

Retouren L + R / klein 2-78

bows l + r / small

Länge x Breite: 150 x 68 mm

length x width

weiß / white

23 00 14

10 Paar / pairs

1 Paar / pair

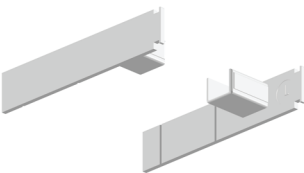

Seitendeckel L + R, Art. 600 teilbar auf 78 und 48 mm

side cap l + r

can be cut to size to 78 and 48 mm

weiß / white

23 00 28

100 Paar / pairs

100 Paar / pairs

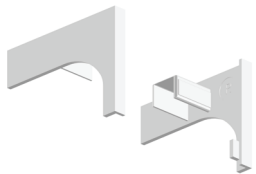

Winkelecken L + R, Art. 602 transparent

angle l + r

transparent

für 50 mm Blende /
for pelmet of 50 mm

23 00 35

100 Paar / pairs

100 Paar / pairs

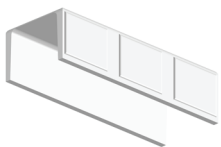

U-Verbindungszapfen

connector

transparent / transparent

23 00 33

200 Stück / pieces

100 Stück / pieces

SYSTEM CM

SYSTEM 3 - 88

BEZEICHNUNG

DESCRIPTION

ARTIKEL-NR.

ARTICLE-NO.

VPE

PU

PREISEINHEIT

PRICE-UNIT

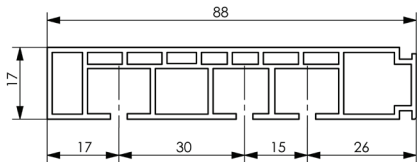

CM - Schiene 3-88

CM - rail

Länge: 600 cm

length

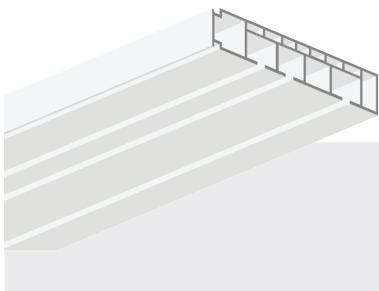

weiß / white

41 00 35

5 Längen / lengths

1 Meter / meter

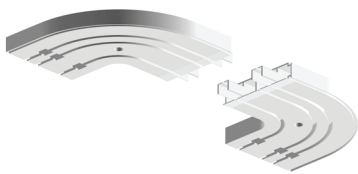

Retouren L + R 3-88

bows l + r

Länge x Breite: 150 x 150 mm

length x width

weiß / white

23 00 24

10 Paar / pairs

1 Paar / pair

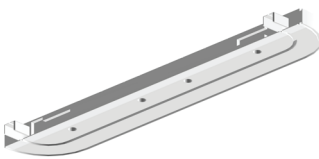

Retourenpaar - universell / rund teilbar

bow pair - universal / round can be cut to size

Länge x Breite: 400 x 60 mm

length x width

weiß / white

23 00 07

20 Stück / pieces

1 Stück / piece

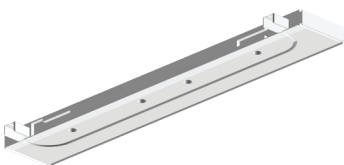

Retourenpaar - universell / eckig teilbar

bow pair - universal / angular can be cut to size

Länge x Breite: 400 x 60 mm

length x width

weiß / white

23 00 08

20 Stück / pieces

1 Stück / piece

KUNSTSTOFFSCHIENEN

PLASTIC RAILS

BEZEICHNUNG

DESCRIPTION

ARTIKEL-NR.

ARTICLE-NO.

VPE

PU

PREISEINHEIT

PRICE-UNIT

Außenbogen 3-88

outer bow

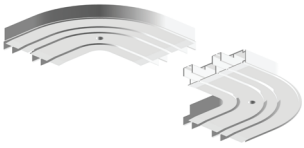

Länge x Breite: 150 x 150 mm

length x width

weiß / white

23 00 20

20 Stück / pieces

1 Stück / piece

Innenbogen 3-88

inner bow

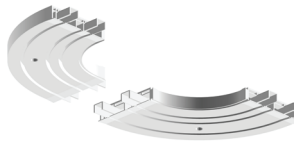

Länge x Breite: 165 x 165 mm

length x width

weiß / white

23 00 22

10 Stück / pieces

1 Stück / piece

Außenbogen 3-88 mit Gradeinteilung

outer bow
with graduation

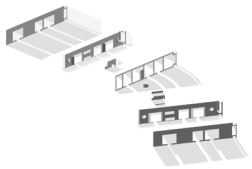

weiß / white

23 00 21

20 Stück / pieces

1 Stück / piece

Innenbogen 3-88 mit Gradeinteilung

inner bow
with graduation



weiß / white

23 00 23

10 Stück / pieces

1 Stück / piece

SYSTEM 3 - 88

BEZEICHNUNG

DESCRIPTION

ARTIKEL-NR.

ARTICLE-NO.

VPE

PU

PREISEINHEIT

PRICE-UNIT



Adapter 3-88
für Bögen mit Gradeinteilung
adapter for bows
with graduation

weiß / white

23 00 39

50 Stück / pieces

1 Stück / piece

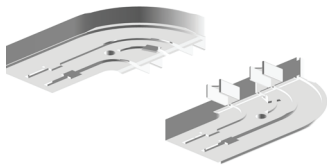

Retouren L + R / klein 3-88
bows l + r / small

Länge x Breite: 150 x 68 mm
length x width

weiß / white

23 00 25

10 Paar / pairs

1 Paar / pair

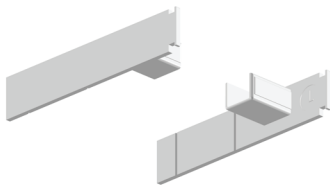

Seitendeckel L + R, Art. 600
teilbar auf 78 und 48 mm
side cap l + r
can be cut to size to 78 and 48 mm

weiß / white

23 00 28

100 Paar / pairs

100 Paar / pairs

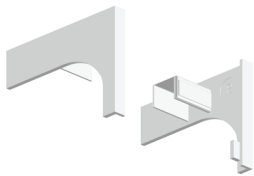

Winkelecken L + R, Art. 602
transparent
angle l + r
transparent

für 50 mm Blende /
for pelmet of 50 mm

23 00 35

100 Paar / pairs

100 Paar / pairs

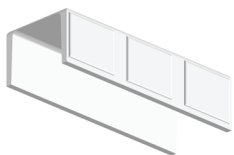

U-Verbindungszapfen
connector

transparent / transparent

23 00 33

200 Stück / pieces

100 Stück / pieces

KUNSTSTOFFSCHIENEN

PLASTIC RAILS

SYSTEM 3 - 112

BEZEICHNUNG

DESCRIPTION

ARTIKEL-NR.

ARTICLE-NO.

VPE

PU

PREISEINHEIT

PRICE-UNIT

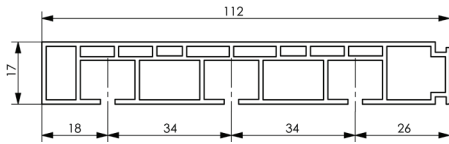

CM – Schiene 3-112

CM – rail

Länge: 600 cm

length

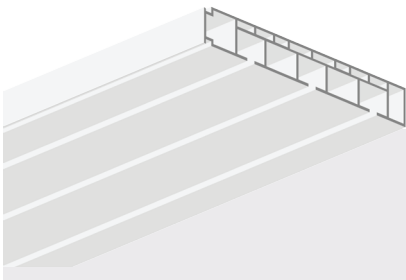

weiß / white

41 00 37

5 Längen / lengths

1 Meter / meter



Retourenpaar – universell / rund teilbar

bow pair – universal / round
can be cut to size

Länge x Breite: 400 x 60 mm

length x width

weiß / white

23 00 07

20 Stück / pieces

1 Stück / piece

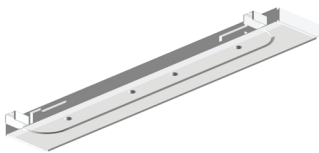

Retourenpaar – universell / eckig teilbar

bow pair – universal / angular
can be cut to size

Länge x Breite: 400 x 60 mm

length x width

weiß / white

23 00 08

20 Stück / pieces

1 Stück / piece

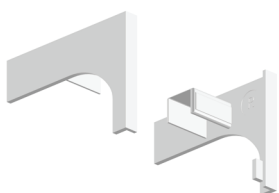

Winklecken L + R, Art. 602

transparent

angle l + r
transparent

für 50 mm Blende /
for pelmet of 50 mm

23 00 35

100 Paar / pairs

100 Paar / pairs

SYSTEM 3 - 112

BEZEICHNUNG

DESCRIPTION

ARTIKEL-NR.

ARTICLE-NO.

VPE

PU

PREISEINHEIT

PRICE-UNIT

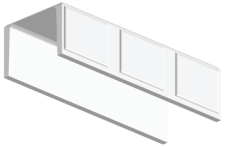

U-Verbindungzapfen

connector

transparent / transparent

23 00 33

200 Stück / *pieces*

100 Stück / *pieces*

KUNSTSTOFFSCHIENEN

PLASTIC RAILS

ZUBEHÖR

BEZEICHNUNG

DESCRIPTION

ARTIKEL-NR.

ARTICLE-NO.

VPE

PU

PREISEINHEIT

PRICE-UNIT



Aufklipsblende in Ringen à 50 m

plug-in pelmet
in rings with 50 m

50 mm breit 50 mm wide

weiß / white	45 00 19	50 Meter / meters	100 Meter / meters
kirschbaum / cherry tree	45 00 22	50 Meter / meters	100 Meter / meters
eiche-hell / light oak	45 00 26	50 Meter / meters	100 Meter / meters
mahagoni / mahogany	45 00 36	50 Meter / meters	100 Meter / meters
buche / beech	45 00 39	50 Meter / meters	100 Meter / meters
nussbaum / walnut	45 00 63	50 Meter / meters	100 Meter / meters
silber-matt / silver matt	45 00 41	50 Meter / meters	100 Meter / meters
platin-antik / platinum-antique	45 00 78	50 Meter / meters	100 Meter / meters
kupfer-antik / copper-antique	45 00 79	50 Meter / meters	100 Meter / meters

75 mm breit 75 mm wide

weiß / white	45 00 20	50 Meter / meters	100 Meter / meters
--------------	----------	-------------------	--------------------



Faltenleggleiter, Art. 603 fold glider

49 00 03	1.000 Stück / pieces	100 Stück / pieces
----------	----------------------	--------------------



Faltenleg- Schleudergleiter, Art. 612 K fold flinging glider

Kugelrolle 8 mm Ø ball roll	49 00 20	200 Stück / pieces	100 Stück / pieces
--------------------------------	----------	--------------------	--------------------

ZUBEHÖR

BEZEICHNUNG

DESCRIPTION

ARTIKEL-NR.

ARTICLE-NO.

VPE

PU

PREISEINHEIT

PRICE-UNIT

**Faltenleg-Rolle, Art. 613 K***fold roll***Kugelrolle 8 mm Ø***ball roll***49 00 23**1.000 Stück / *pieces*100 Stück / *pieces***Zwischenfeststeller, Art. 609***intermediate stop***49 00 06**500 Stück / *pieces*100 Stück / *pieces***Endfeststeller, Art. 618****vierkant***end stop**square***49 00 27**500 Stück / *pieces*100 Stück / *pieces***Universal-
Endfeststeller, Art. 619***universal end stop***49 00 28**500 Stück / *pieces*100 Stück / *pieces***Universal-
End- /
Zwischenfeststeller, Art. 621***universal end- /**intermediate stop***49 00 29**500 Stück / *pieces*100 Stück / *pieces*

KUNSTSTOFFSCHIENEN

PLASTIC RAILS

BEZEICHNUNG

DESCRIPTION

ARTIKEL-NR.

ARTICLE-NO.

VPE

PU

PREISEINHEIT

PRICE-UNIT

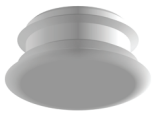

Abdeckstopfen, Art. 610

9 mm Ø

plastic plug

9 mm Ø

weiß / white

49 00 08

2.000 Stück / pieces

1.000 Stück / pieces



Brettklemme, Art. 629

verzinkt, 35 mm lang

rail holder

35 mm long, zinc coated

51 00 01

100 Stück / pieces

100 Stück / pieces



Winkelträger 3,5 mm

gelocht

angle bracket 3.5 mm

punched

60 x 120 mm grau / grey

51 00 23

50 Stück / pieces

100 Stück / pieces

60 x 160 mm grau / grey

51 00 25

50 Stück / pieces

100 Stück / pieces

60 x 200 mm grau / grey

51 00 27

50 Stück / pieces

100 Stück / pieces

60 x 120 mm weiß / white

51 00 24

50 Stück / pieces

100 Stück / pieces

60 x 160 mm weiß / white

51 00 26

50 Stück / pieces

100 Stück / pieces

60 x 200 mm weiß / white

51 00 28

50 Stück / pieces

100 Stück / pieces

Ausklinkwerkzeug, Art. 633

vierkant

10,5 x 12,0 mm

punching tool

square

10,5 x 12,0 mm

51 00 19

1 Stück / piece

1 Stück / piece

ZUBEHÖR

BEZEICHNUNG

DESCRIPTION

ARTIKEL-NR.

ARTICLE-NO.

VPE

PU

PREISEINHEIT

PRICE-UNIT



**Stufenbohrer, Art. 638
mit Zentrierspitze**
*stepping drill
with centre point*

6,2 mm / 8,8 mm**51 00 20**1 Stück / *piece*1 Stück / *piece*

Gleitfix-Sprühmittel
silicone lubricant

Größe 1 / size 1**75 ml****51 00 02**12 Dosen / *cans*1 Dose / *can***Größe 2 / size 2****150 ml****51 00 03**12 Dosen / *cans*1 Dose / *can***Größe 3 / size 3****400 ml****51 00 04**12 Dosen / *cans*1 Dose / *can*

Sekundenkleber
rapid setting glue

Tube à 3 g / tube of 3 g**51 00 22**10 Stück / *piece*1 Stück / *piece*

SYSTEM BM



möller

SYSTEM BM

System 1-37

326

System 2-57

328

System 3-94

330

Zubehör

332



No limits

Die BM-Schiene eröffnet ungeahnte Kombinationsmöglichkeiten. Sie wurde als einfaches Stecksystem konzipiert und wird dadurch zu einem wahren Multitalent, das flexibel, erweiterbar und leicht ist.

The BM rails opens up unimagined possibilities of combining. It was designed as a simple plug-in system and thus, develops into a true all-rounder, which is flexible, expandable and light.

KUNSTSTOFFSCHIENEN

PLASTIC RAILS



System BM

Das kombinierfreudige System von MÖLLER

Alle Bogensegmente und Schienen sind mit der gleichen simplen aber effektiven Technik auf die gewünschte Breite erweiterbar. So entstehen problemlos mit 1-läufigen Schienen 2- bis beliebig läufige Anlagen.

Drei unterschiedliche Schienen-Typen können mit einer weißen Kunststoffblende in 50 mm Breite kombiniert werden. Rundbögen und Seitendeckel runden das Sortiment ab.

The easily-combined MÖLLER system

All curve segments and rails can be expanded to the desired width using the same simple yet effective technique. Consequently, 1-track rails can easily be combined to form 2- or more track sets.

Three different rail types can be combined with a white PVC pelmet of 50 mm width. Round bows and side covers complete the program.

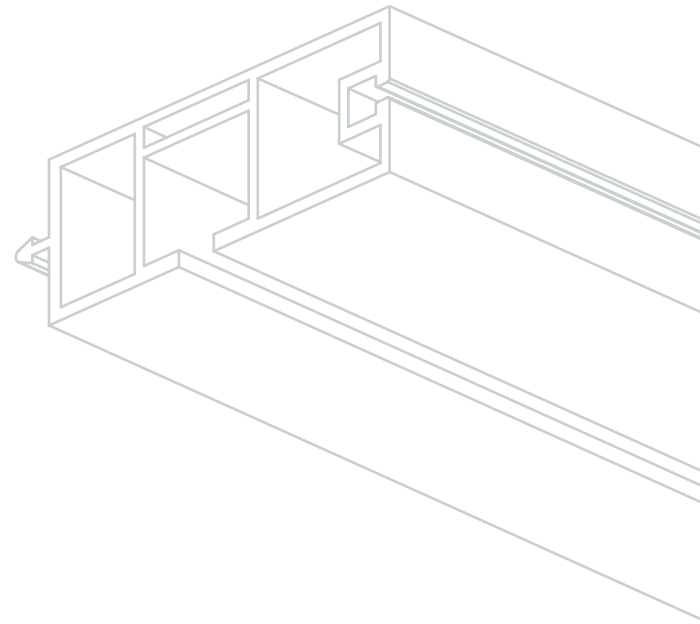

KUNSTSTOFFSCHIENEN

PLASTIC RAILS



**ANZAHL DER
SCHIENENLÄUFE
BELIEBIG ERWEITERBAR**
*NUMBER OF RAIL TRACKS
FREELY EXPANDABLE*



**EINFACHES
STECKSYSTEM**
SIMPLE PLUG-IN SYSTEM

DEKORATIONS-/ EINSATZMÖGLICHKEITEN

POSSIBLE USES IN DECORATION

- als Gardinenschiene mit dekorativer Blende für leichte und transparente Stoffe
- Der Kunststoff-Paneelwagen kann als Flächenvorhang ergänzt werden (siehe System Aluminium, Rubrik: Flächenvorhang)
- *as a curtain rail with decorative pelmets for lightweight transparent fabrics*
- *the plastic panel runner can be added to from panel curtain (see System Aluminium, section: Panel Curtain)*

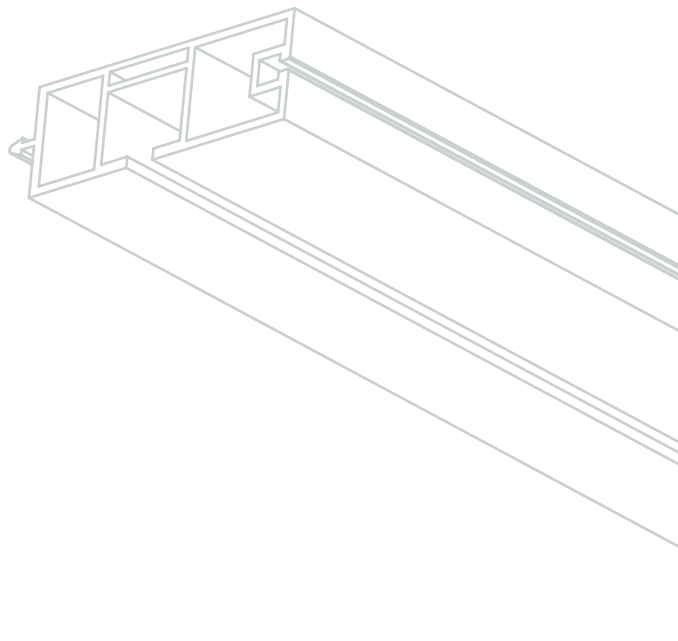

MONTAGE

INSTALLATION

- Die Deckenmontage erfolgt durch die vorbereiteten Bohrlöcher
- Dekorative Aufklipsblenden in 50 mm Breite werden auf die Blendenaufnahme der Vorhangschiene geklippt oder aufgeschoben
- Mit einer 1-läufigen Schiene können durch Zusammenstecken 2- bis beliebig läufige Garnituren konfektioniert werden
- *to install on ceiling, use the pre-drilled holes*
- *decorative clip-on pelmets 50 mm in width are clipped or pushed onto the cover holder of the curtain rail*
- *Single-track interior rails are combined to form systems with two or more tracks.*

SYSTEMMERKMALE

SPECIFICATIONS

AUFBAU

Kunststoffprofil mit integrierter Blenden-
aufnahme; vorgebohrt für Deckenmontage
im Abstand von 50 cm bis 60 cm

STÄRKE

13 mm

LÄNGE

600 cm

SONDERMASSE

auf Anfrage
(Mindestmenge 100 Stück je Abmessung)

VERPACKUNG

5 Stück je Länge im Bund

FARBEN

weiß

STRUCTURE

U-PVC profile with integrated reception
for pelmets; pre-drilled for ceiling
installation at distances of 50 to 60 cm

THICKNESS

13 mm

LENGTH

600 cm

SPECIAL LENGTH

on request
(minimum 100 pieces per dimension)

PACKING

5 pieces per length in bundle

COLOURS

white

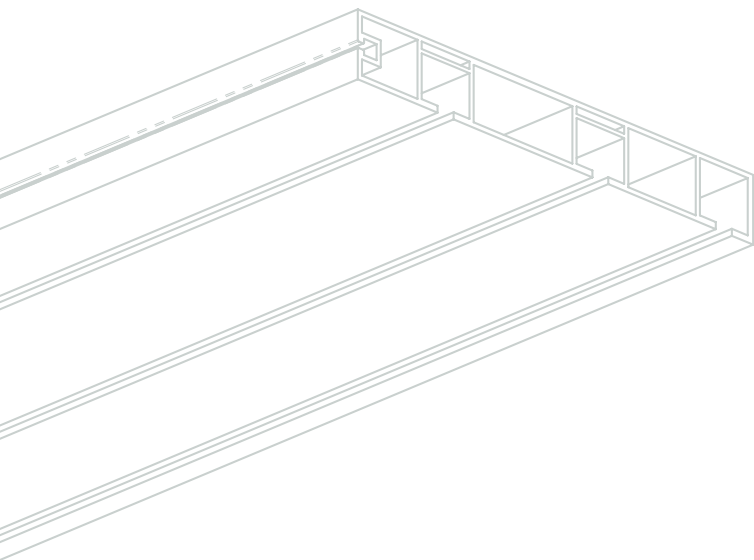

KUNSTSTOFFSCHIENEN

PLASTIC RAILS

SCHIENENTYPEN

TYPES OF RAILS

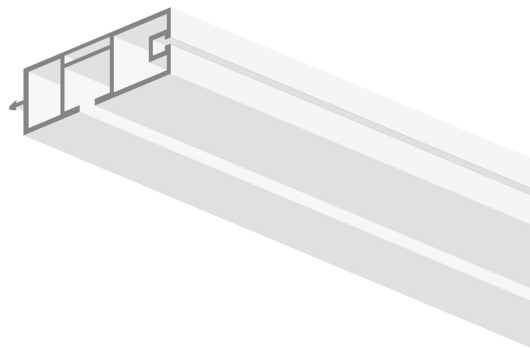

1 LAUF 1 TRACK

1-37

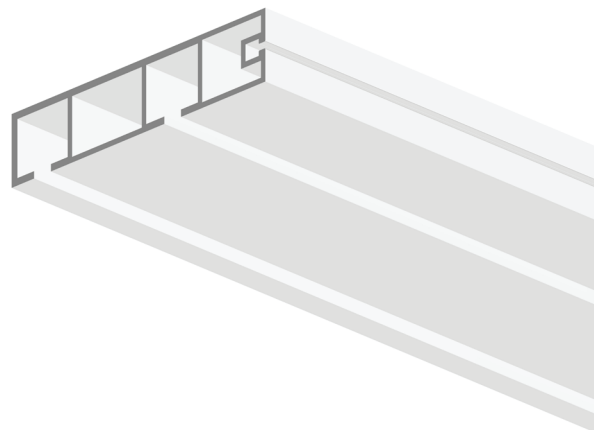

2 LAUF 2 TRACK

2-57

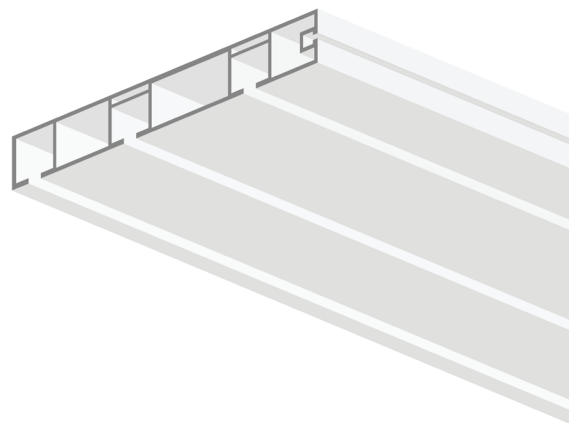

3 LAUF 3 TRACK

3-94

SYSTEM BM

SCHIENEN-DEKORE

DECORS OF RAILS

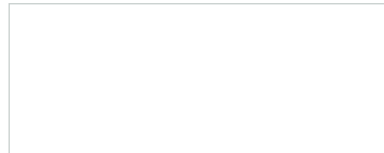

weiß / *white*

BLENDEN-DEKORE

DECORS OF PELMETS

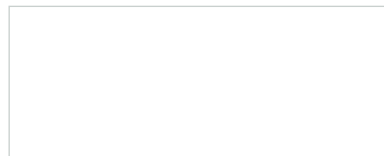

weiß / *white*



KUNSTSTOFFSCHIENEN

PLASTIC RAILS

EXPLOSIONSZEICHNUNG

EXPLODED VIEW

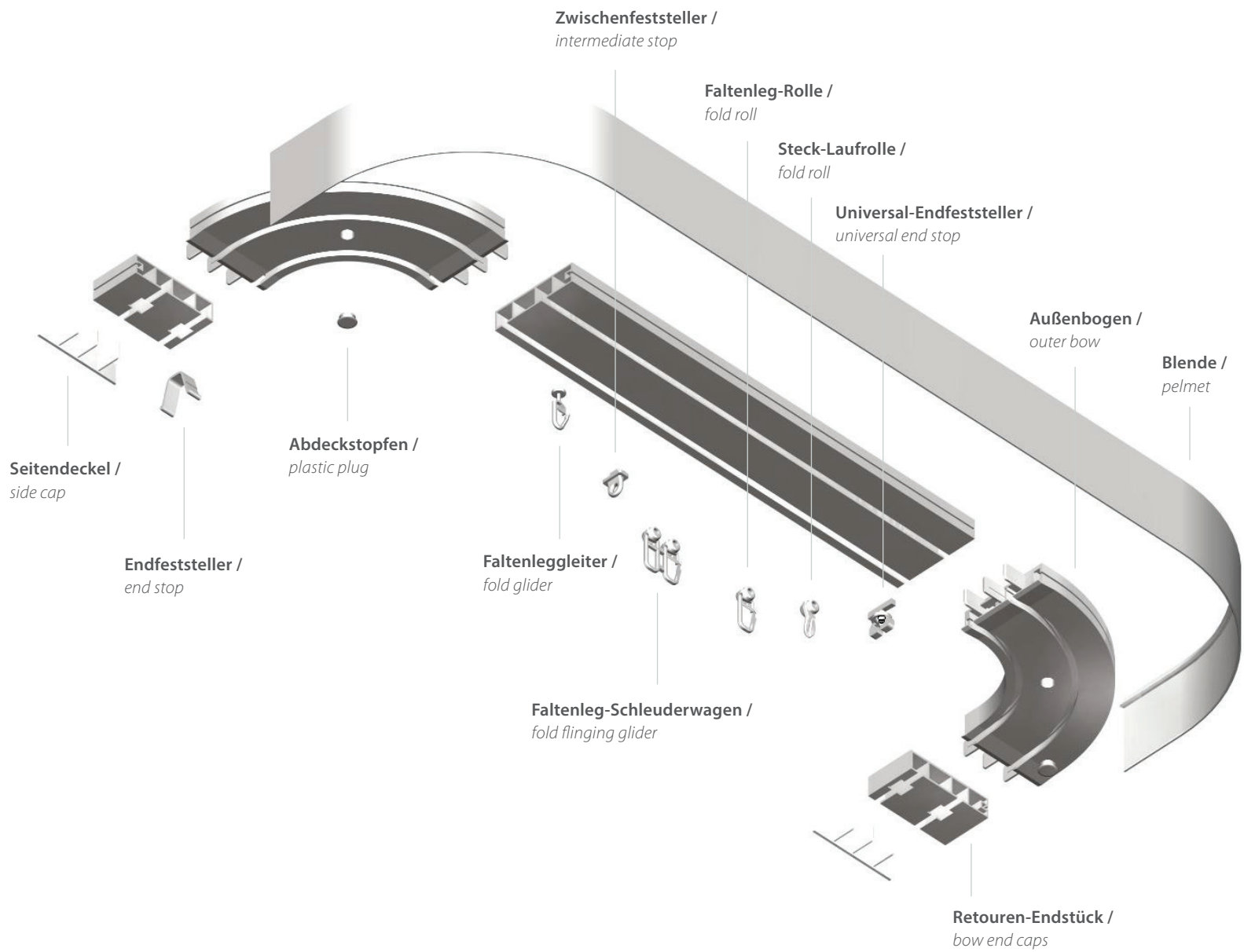

SYSTEM BM

SYSTEM 1 - 37

BEZEICHNUNG
DESCRIPTION

ARTIKEL-NR.
ARTICLE-NO.

VPE
PU

PREISEINHEIT
PRICE-UNIT

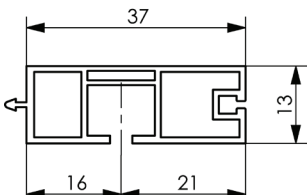

BM – Schiene 1-37

BM – rail

Länge: 600 cm
length

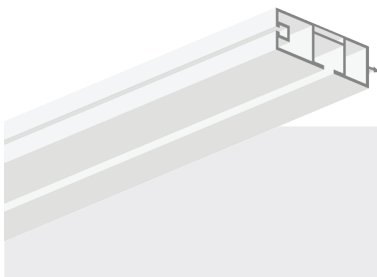

weiß / white

12 00 11

5 Längen / *lengths*

1 Meter / *meter*



Außenbogen 1-37

outer bow

Länge x Breite: 155 x 155 mm
length x width

weiß / white

12 00 01

150 Stück / *pieces*

1 Stück / *piece*



**Retourenendstück 1-37
für Außenbogen**

end cap for outer bow

Länge: 32 mm
length

weiß / white

12 00 05

300 Stück / *pieces*

100 Stück / *pieces*

KUNSTSTOFFSCHIENEN

PLASTIC RAILS

BEZEICHNUNG

DESCRIPTION

ARTIKEL-NR.

ARTICLE-NO.

VPE

PU

PREISEINHEIT

PRICE-UNIT

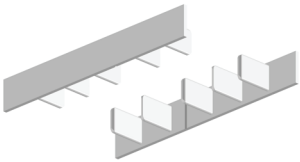

Seitendeckel, universell teilbar

side cap, universal
can be cut to size

weiß / white

12 00 42

500 Stück / pieces

100 Stück / pieces

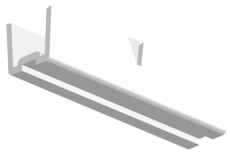

U-Verbindungszapfen connector

weiß / white

12 00 43

100 Stück / pieces

100 Stück / pieces

SYSTEM BM

SYSTEM 2 - 57

BEZEICHNUNG

DESCRIPTION

ARTIKEL-NR.

ARTICLE-NO.

VPE

PU

PREISEINHEIT

PRICE-UNIT

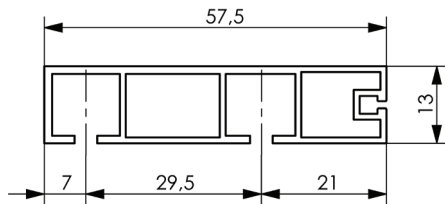

BM - Schiene 2-57

BM - rail

Länge: 600 cm

length

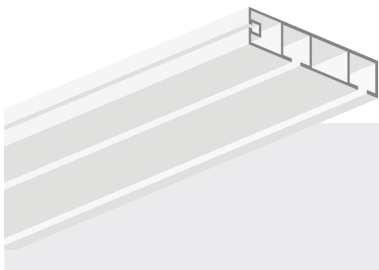

weiß / white

12 00 23

5 Längen / lengths

1 Meter / meter



Außenbogen 2-57

outer bow

Länge x Breite: 118 x 118 mm

length x width

weiß / white

12 00 13

150 Stück / pieces

1 Stück / piece

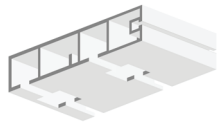

Retourenendstück 2-57

für Außenbogen

end cap for outer bow

Länge: 32 mm

length

weiß / white

12 00 17

300 Stück / pieces

100 Stück / pieces

KUNSTSTOFFSCHIENEN

PLASTIC RAILS

BEZEICHNUNG

DESCRIPTION

ARTIKEL-NR.

ARTICLE-NO.

VPE

PU

PREISEINHEIT

PRICE-UNIT

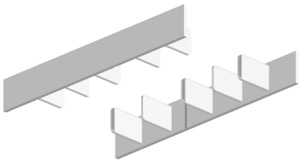

Seitendeckel, universell teilbar

side cap, universal
can be cut to size

weiß / white

12 00 42

500 Stück / pieces

100 Stück / pieces

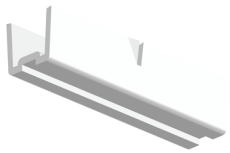

U-Verbindungszapfen

connector

weiß / white

12 00 43

100 Stück / pieces

100 Stück / pieces

SYSTEM BM

SYSTEM 3 - 94

BEZEICHNUNG

DESCRIPTION

ARTIKEL-NR.

ARTICLE-NO.

VPE

PU

PREISEINHEIT

PRICE-UNIT

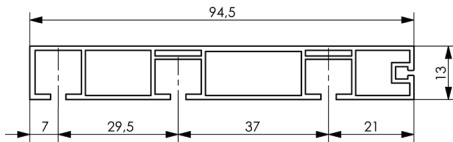

BM - Schiene 3-94

BM - rail

Länge: 600 cm

length

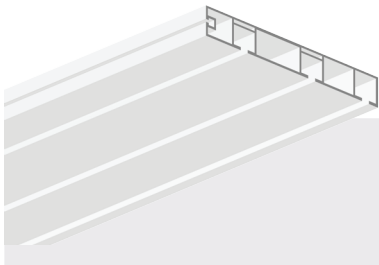

weiß / white

12 00 41

5 Längen / lengths

1 Meter / meter

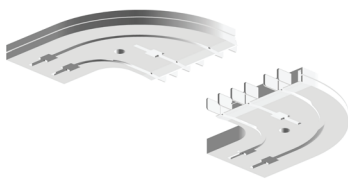

Retouren L + R 3-94

bows l + r

Länge x Breite: 150 x 108 mm

length x width

weiß / white

12 00 25

100 Paar / pairs

1 Paar / pair



Seitendeckel, universell teilbar

side cap, universal
can be cut to size

weiß / white

12 00 42

500 Stück / pieces

100 Stück / pieces

KUNSTSTOFFSCHIENEN

PLASTIC RAILS

BEZEICHNUNG

DESCRIPTION

ARTIKEL-NR.

ARTICLE-NO.

VPE

PU

PREISEINHEIT

PRICE-UNIT

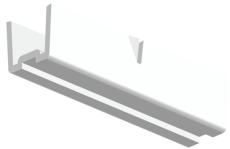

U-Verbindungszapfen

connector

weiß / white

12 00 43

100 Stück / pieces

100 Stück / pieces

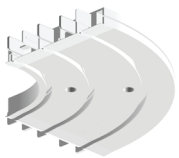

Durch die Verbindung
der Bögen 1-37 und 2-57
können 3-läufige Bögen (3-94)
erzeugt werden.

Connecting the bows 1-37 and 2-57
you can receive a bow 3-94.



Außenbogen 1-37

outer bow

Länge x Breite: 155 x 155 mm

length x width

weiß / white

12 00 01

150 Stück / pieces

1 Stück / piece



Außenbogen 2-57

outer bow

Länge x Breite: 118 x 118 mm

length x width

weiß / white

12 00 13

150 Stück / pieces

1 Stück / piece

SYSTEM BM

ZUBEHÖR

BEZEICHNUNG

DESCRIPTION

ARTIKEL-NR.

ARTICLE-NO.

VPE

PU

PREISEINHEIT

PRICE-UNIT



**Blende 50 mm
in Ringen à 50 m**
*pelmet 50 mm
in rings à 50 m*

weiß / white

45 00 47

50 Meter / meters

100 Meter / meters



Faltenleg-Gleiter, Art. 603
fold glider

49 00 03

1.000 Stück / pieces

100 Stück / pieces



**Faltenleg-
Schleuderwagen, Art. 612 K**
fold flinging glider

Kugelrolle 8 mm Ø
ball roll

49 00 20

200 Stück / pieces

100 Stück / pieces



Faltenleg-Rolle, Art. 613 K
fold roll

Kugelrolle 8 mm Ø
ball roll

49 00 23

1.000 Stück / pieces

100 Stück / pieces



Zwischenfeststeller, Art. 609
intermediate stop

49 00 06

500 Stück / pieces

100 Stück / pieces

KUNSTSTOFFSCHIENEN

PLASTIC RAILS

BEZEICHNUNG

DESCRIPTION

ARTIKEL-NR.

ARTICLE-NO.

VPE

PU

PREISEINHEIT

PRICE-UNIT



Endfeststeller, Art. 618

vierkant

end stop

square

49 00 27

500 Stück / pieces

100 Stück / pieces



Universal- Endfeststeller, Art. 619

universal end stop

49 00 28

500 Stück / pieces

100 Stück / pieces



Universal- End- / Zwischenfeststeller, Art. 621

universal end- /

intermediate stop

49 00 29

500 Stück / pieces

100 Stück / pieces

ZUBEHÖR

BEZEICHNUNG

DESCRIPTION

ARTIKEL-NR.

ARTICLE-NO.

VPE

PU

PREISEINHEIT

PRICE-UNIT

**Abdeckstopfen, Art. 610****9 mm Ø***plastic plug**9 mm Ø***weiß / white****49 00 08**

2.000 Stück / pieces

1.000 Stück / pieces

Ausklinkwerkzeug, Art. 633**vierkant****10,5 x 12,0 mm***punching tool**square**10,5 x 12,0 mm***51 00 19**

1 Stück / piece

1 Stück / piece

Stufenbohrer, Art. 638**mit Zentrierspitze***stepping drill**with centre point***6,2 mm / 8,8 mm****51 00 20**

1 Stück / piece

1 Stück / piece

Gleitfix-Sprühmittel*silicone lubricant***Größe 1 / size 1****75 ml****51 00 02**

12 Dosen / cans

1 Dose / can

Größe 2 / size 2**150 ml****51 00 03**

12 Dosen / cans

1 Dose / can

Größe 3 / size 3**400 ml****51 00 04**

12 Dosen / cans

1 Dose / can

Sekundenkleber*rapid setting glue***Tube à 3 g / tube of 3 g****51 00 22**

10 Stück / pieces

1 Stück / piece

KUNSTSTOFFPROFILE

PLASTIC PROFILES

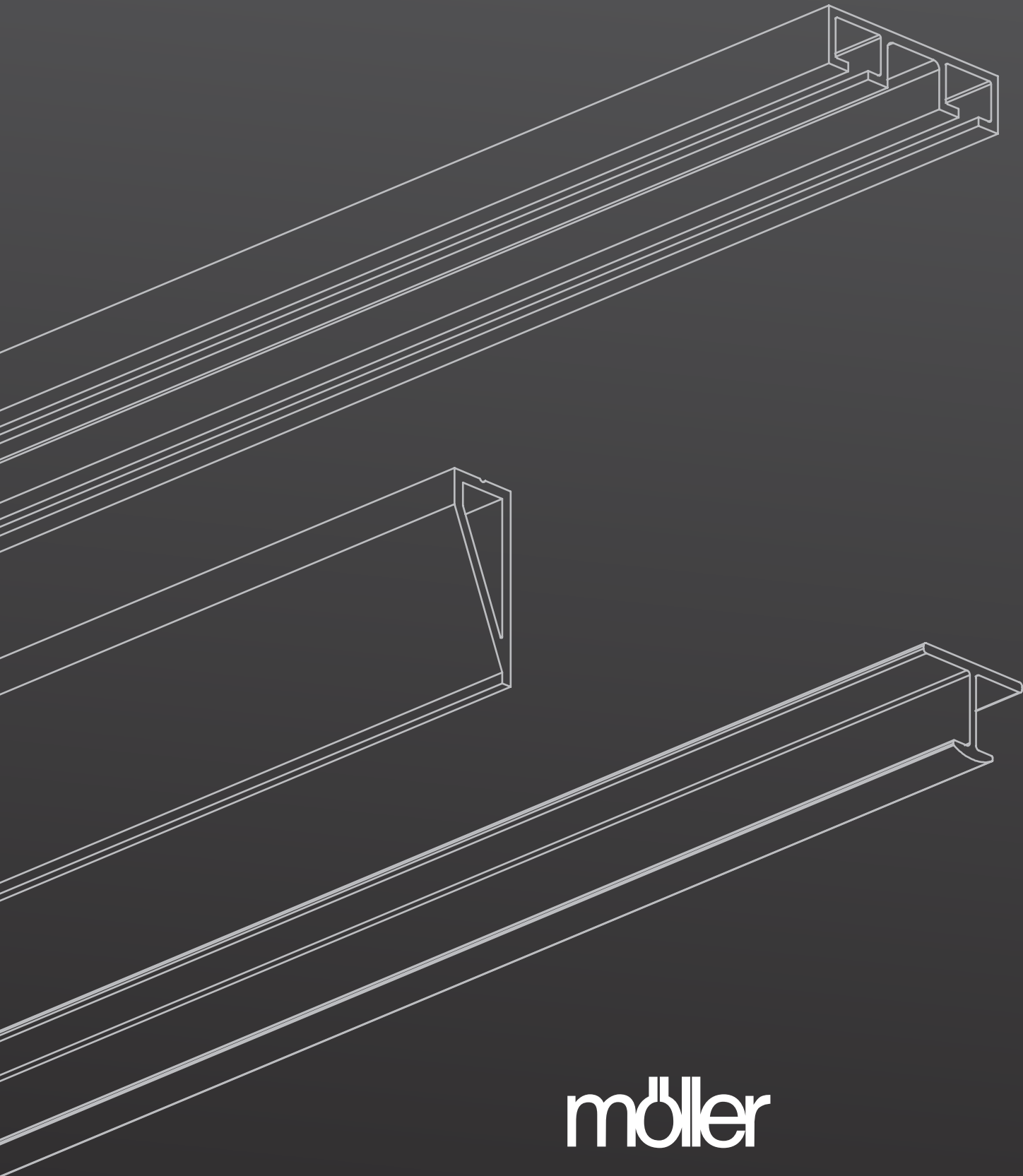

möller

KUNSTSTOFFSCHIENEN

PLASTIC RAILS

KUNSTSTOFFPROFILE

PLASTIC PROFILES

DOPPELFLANSCHIGE VORHANGSCHIENE

CURTAIN RAIL WITH DOUBLE FLANGE

346

EINFLANSCHIGE VORHANGSCHIENE

CURTAIN RAIL WITH SINGLE FLANGE

346

2-LÄUFIGE INNENLAUFSCHIENE

DOUBLE-TRACK INNER RAIL

347

U-VORHANGSCHIENE

U-CURTAIN RAIL

347

KUNSTSTOFF-PANEELWAGEN

PVC-PANEL TRACK

348





Just for you

Wenn Sie etwas Besonderes wünschen, zeigen wir Profil.
Nutzen Sie unser technisches Know-how und
realisieren Sie mit uns Ihr Sonderprofil.

*If you want something special, we may be of service.
Profit from our technical know-how and
implement your special profile with us.*

Kunststoffprofile

PLASTIC PROFILES

Kunststoff-Manufaktur

Möller-Profile finden ihren Einsatz auch in anderen Bereichen. Unsere Konstruktionsabteilung sowie der eigene Werkzeugbau garantieren, dass Ihre Anforderungen präzise, schnell und wirtschaftlich umgesetzt werden.

Aus verschiedenen Werkstoffen produzieren wir für Sie Sonderprofile in vielfältigen Farben und Formen.

Plastic manufactory

Möller profiles are also used in other sectors. Our design departments as well as our tool manufacturing department guarantee precise, quick and economic implementation of your requirements.

We produce special profiles in versatile colours and form out of different materials.

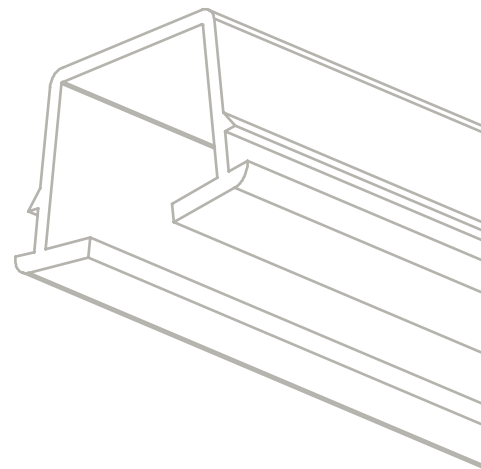

KUNSTSTOFFSCHIENEN

PLASTIC RAILS



SYSTEMMERKMALE

SPECIFICATIONS

AUFBAU

Die PVC-Profile verfügen über sehr gute Gleiteigenschaften.

STÄRKE

diverse

LÄNGE

500 cm / 600 cm

SONDERMASSE

auf Anfrage

VERPACKUNG

auf Anfrage

FARBEN

weiß

SONDERFARBEN

auf Anfrage

STRUCTURE

The PVC-profiles have very good sliding qualities.

THICKNESS

various ones

LENGTH

500 cm / 600 cm

SPECIAL LENGTH

on request

PACKING

on request

COLOURS

white

SPECIAL COLOURS

on request

SCHIENEN-DEKORE

DECORS OF RAILS

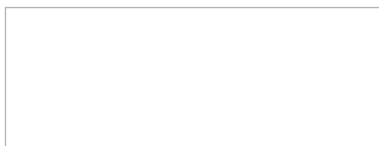

weiß / white

KUNSTSTOFFSCHIENEN

PLASTIC RAILS



KUNSTSTOFFPROFILE

PLASTIC PROFILES

SCHIENENTYPEN

TYPES OF RAILS

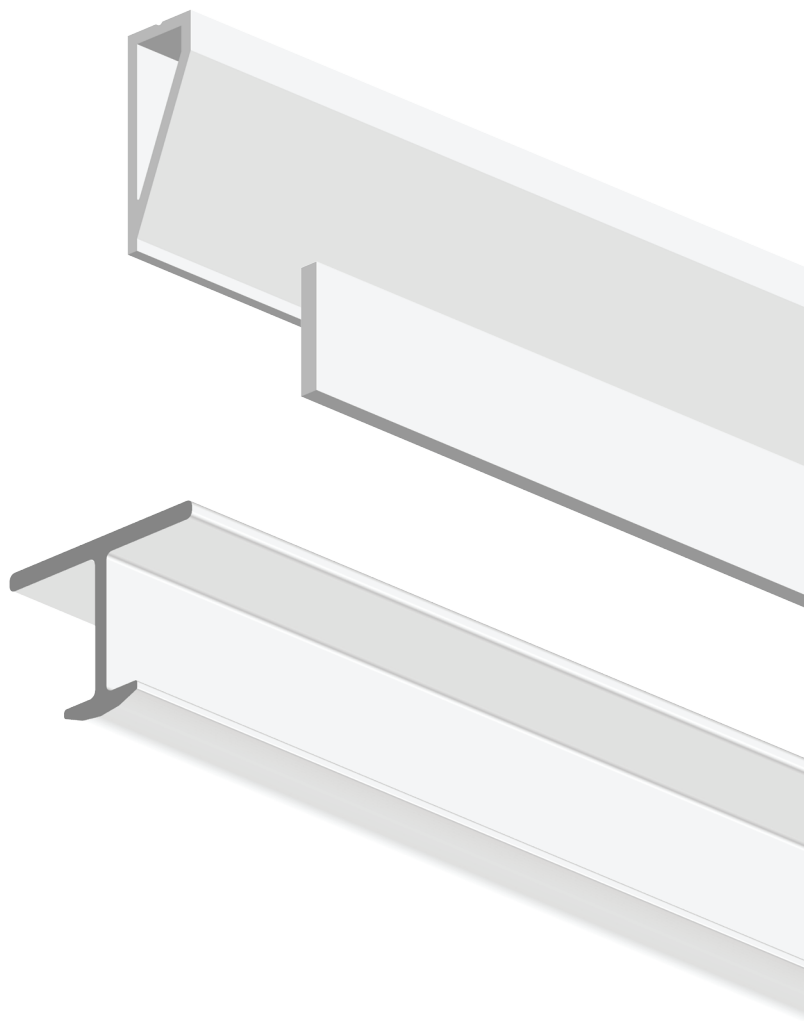

**KUNSTSTOFF-PANEELWAGEN
INKL. KLETTBAND UND
BESCHWERUNGSPROFIL**

*PLASTIC PANEL TRACK WITH
VELCRO AND BOTTOM WEIGHT
PROFILE*

**DOPPELFLANSCHIGE
VORHANGSCHIENE**

*CURTAIN RAIL WITH
DOUBLE FLANGE*

KUNSTSTOFFSCHIENEN

PLASTIC RAILS



EINFLANSCHIGE VORHANGSCHIENE

*CURTAIN RAIL WITH
SINGLE FLANGE*

U-VORHANGSCHIENE FÜR GLEITER

*U-CURTAIN RAIL
FOR GLIDER*

ZWEILÄUFIGE INNENLAUFSCHIENE

*DOUBLE-TRACK
INNER RAIL*

KUNSTSTOFFPROFILE

PLASTIC PROFILES

BEZEICHNUNG

DESCRIPTION

ARTIKEL-NR.

ARTICLE-NO.

VPE

PU

PREISEINHEIT

PRICE-UNIT

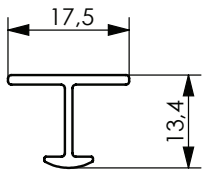

**Doppelflanschige
Vorhangschiene 200**
alle 14 cm wechelseitig gelocht
*curtain rail with double flange
punched every 14 cm by turns*

Länge: 500 cm
length

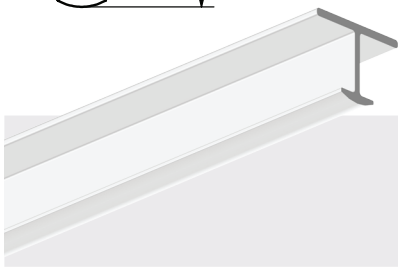

weiß / white

46 00 02

50 Längen / lengths

100 Meter / meter

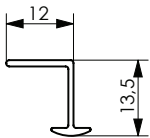

**Einflanschige
Vorhangschiene 201**
alle 14 cm gelocht
*curtain rail with single flange
punched every 14 cm*

Länge: 500 cm
length



weiß / white

46 00 14

50 Längen / lengths

100 Meter / meter



**Gleiter 640
für T-Schienen**
glider for t-rails

weiß / white

49 00 31

1.000 Stück / pieces

100 Stück / pieces

KUNSTSTOFFSCHIENEN

PLASTIC RAILS

BEZEICHNUNG

DESCRIPTION

ARTIKEL-NR.

ARTICLE-NO.

VPE

PU

PREISEINHEIT

PRICE-UNIT

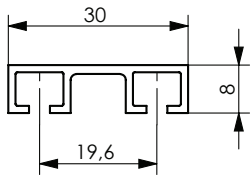

**Zweiläufige
Innenlaufschiene 506**
30 mm breit, Laufnutenweite 4 mm
*double-track inner rail,
30 mm wide, clearance of the rail, 4 mm*

Länge: 600 cm
length

weiß / white

46 00 18

20 Längen / lengths

100 Meter / meter

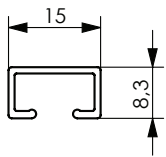

U-Vorhangschiene 507 für Gleiter
15 mm breit, Laufnutenweite 6 mm,
alle 14 cm gelocht
*u-curtain rail for glider,
15 mm wide, clearance of the rail, 6 mm
punched every 14 cm*

Länge: 500 cm
length

weiß / white

46 00 27

50 Längen / lengths

100 Meter / meter



Faltenleggleiter 603
fold glider

weiß / white

49 00 03

1.000 Stück / pieces

100 Stück / pieces



Zwischenfeststeller 609
intermediate stop

weiß / white





49 00 06

500 Stück / pieces

100 Stück / pieces

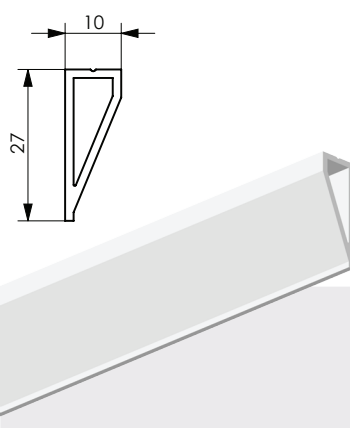

KUNSTSTOFFPROFILE

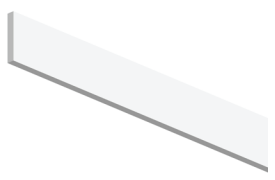
PLASTIC PROFILES

	BEZEICHNUNG <i>DESCRIPTION</i>	ARTIKEL-NR. <i>ARTICLE-NO.</i>	VPE <i>PU</i>	PREISEINHEIT <i>PRICE-UNIT</i>
	Kunststoff-Paneelwagen 1010 inkl. Klettband <i>PVC - panel track</i> <i>with Velcro</i> Länge: 600 cm <i>length</i>			
	<i>weiß / white</i>	15 00 13	10 Längen / <i>lengths</i>	1 Meter / <i>meter</i>
	Enddeckel L + R 1031 <i>end cap l + r</i>			
	<i>weiß / white</i>	15 00 08	100 Paar / <i>pairs</i>	100 Paar / <i>pairs</i>
	Schwenkrolle 1030 <i>turnable roll</i>			
		15 00 06	100 Stück / <i>pieces</i>	100 Stück / <i>pieces</i>
	X-Gleiter 1032 <i>x-glider</i>			
		15 00 09	500 Stück / <i>pieces</i>	100 Stück / <i>pieces</i>
	Beschwerungsprofil Kunststoff 1011 Gewicht: 140 g/m <i>bottom weight profile plastic</i> <i>weight: 140 g/m</i> Länge: 600 cm <i>length</i>			
	<i>weiß / white</i>	15 00 22	10 Längen / <i>lengths</i>	1 Meter / <i>meter</i>

möller

MÖLLER GmbH & Co. KG
Am Kindergarten 1
D-59872 Meschede

 +49 291 2993-0
 info@moeller-profilsysteme.de
 www.moeller-profilsysteme.de